

# SRM3

## Rodless type

## High precision guided rodless cylinder

ø25·ø32·ø40·ø63

### Overview

This is a high precision guided rodless cylinder with two axis high precision linear guide integrated to rodless cylinders ø25 to ø63. Ideal for high precision transfer of parts.

### Features

Thin design with outstanding bending moment

**Safety** (position locking unit option)

The position locking unit which allows mechanical lock can be installed at any portion from stroke limit to end. This increases safety of machinery and equipment.

**Fixing adjustable full-stroke unit securely**

An adjustable full-stroke unit with shock absorber is securely fixed by a dedicated plate nut. Misalignment at the stroke limit is prevented.



## CONTENTS

Series variation	2108
⚠ Safety precautions	2110
● Double acting (SRL3)	2116
● Double acting position locking type (SRM3-Q)	2116
Selection guide	2127
Technical data	2132

SCP*2
CMK2
CMA2
SCM
SCG
SCA2
SCS
CKV2
CA/OV2
SSD
CAT
MDC2
MVC
SMD2
MSD*
FC*
STK
ULK*
JSK/M2
JSG
JSC3
USSD
USC
JSB3
LMB
STG
STS L
LCS
LCG
LCM
LCT
LCY
STR2
UCA2
HCM
HCA
SRL3
SRG3
<b>SRM3</b>
SRT3
MRL2
MRG2
SM-25
CAC4
UCAC2
RCC2
MFC
SHC
GLC
Ending

Rodless type  
High precision guided rodless cylinder





# Safety precautions

Always read this section before starting use.

Refer to Intro 71 for the cylinder and Intro 78 for the cylinder switch.

Individual precautions: rodless cylinder with high precision guide SRM3 Series

## Design & Selection

### 1. Common

#### CAUTION

■ Please watch out when designing intermediate stop circuit.

With a slit rodless cylinder such as the SRL3, some air leaks due to the structure, so braking cannot be controlled with the all ports closed 3-position valve, and it may not be possible to hold the table stop position. Therefore, use a double sided pressurized control circuit having a P/A/B connection 3-position valve.

However, when restart after once pressure dropped, supplying compressed air in de-energized state may lead to table movement, and the table may slide from the origin.

#### Basic circuit diagram

##### ● Horizontal load

If piping is as shown in Fig. 1, equal pressure is applied on both sides of the piston when stopped, and the table does not pop out when restarting.

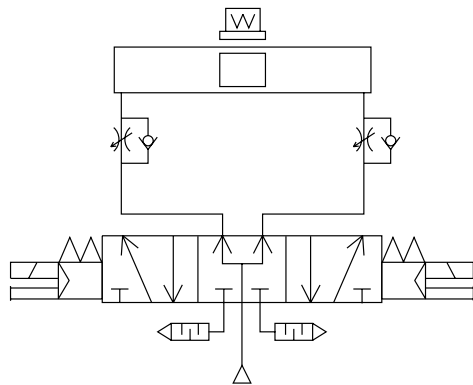

Fig.1

##### ● Vertical load

If a vertical load is applied as shown in Fig. 2, the table will move in the direction of the load. Thus, install a regulator with check valve to reduce the thrust in the load direction and balance the load.

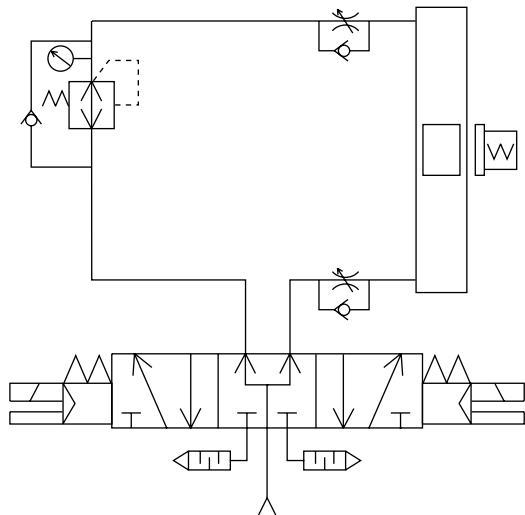
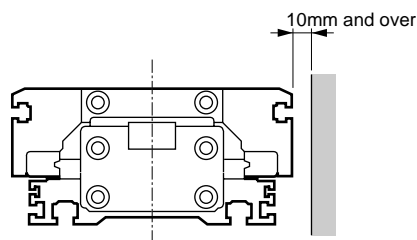

Fig.2

■ The cylinder may malfunction if a magnetic substance, such as a steel plate, is nearby. Move the magnetic substance to at least 10 mm from the side of the table.



■ Do not use in a place where coolant, coolant fluid or oil mist, etc., could come in direct contact with the cylinder.

Always protect the cylinder with a cover if it needs to be installed in such environment.

■ Do not use in a place where foreign matter such as swarf, dust, dust or spatter may come in contact or are suspended in the environment.

If unavoidable because of the cylinder installation position, always provide protection with a cover, etc. Consult with CKD when using in such environment.

■ Balancers, etc.

Do not use for applications that require constant pressurization to only one side such as a balancer.

### 2. Position locking type SRL3-Q

#### CAUTION

■ Cylinder load factor must be 50% or less.

Place a regulator with a check valve on the rod to reduce thrust in the load direction and balance the load.

■ When operating with 500mm/s speed or more, rush speed for position locking mechanism should be 500mm/s or less.

For deceleration method, install an external shock absorber or a deceleration circuit etc.

### Installation & Adjustment

#### 1. Common

#### ⚠ WARNING

#### ■ How to adjust stroke adjustment unit

Adjustable full-stroke and standard shock absorber (SRM3-\*\*-\*\*\*-A1)

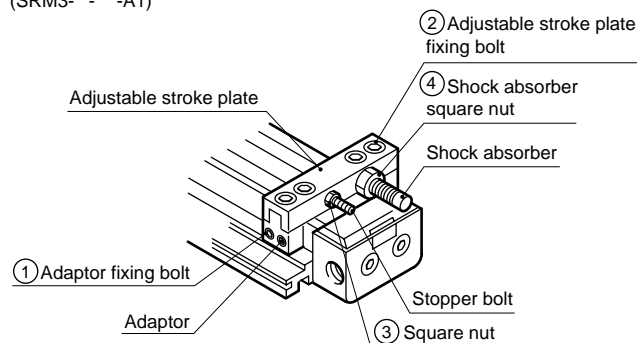

Adjustable full-stroke and light load shock absorber (SRM3-\*\*-\*\*\*-E1)

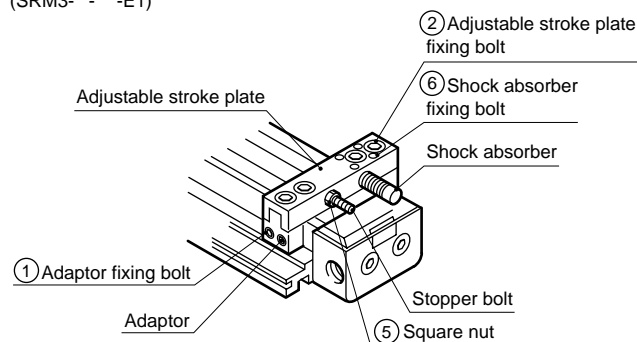

#### (1) Moving the stroke adjustment unit

- Loosening adaptor fixing bolt and adjustable stroke end plate fixing bolt allows to move the adjustable stroke unit.

#### (2) Fixing the stroke adjustment unit

- After moving adjustable stroke unit to the specified position, fix the adaptor fixing bolt and the adjustable stroke end plate fixing bolt using values in Table 1.

Table 1. Adaptor fixing bolt, tightening torque of adjustable stroke end plate fixing bolt

Tightening torque Model	Adaptor fixing bolt N · m	Adjustable stroke plate fixing bolt N · m
SRM3-25	6.2 to 7.6	6.2 to 7.6
SRM3-32	6.2 to 7.6	6.2 to 7.6
SRM3-40	10.4 to 12.8	10.4 to 12.8
SRM3-63	19.4 to 23.8	19.4 to 23.8

- Fix adjustable stroke plate with fixing bolt after check if no gap exists between the adaptor and the tube. Thereafter tighten the adaptor fixing bolt.

#### (3) Stroke adjustment using stopper bolt

Loosen the stopper bolt fixing nut, turn the stopper bolt, then adjust the stroke.

After adjusting the stroke, tighten and fix the stopper bolt lock nut using values in Table 2 or 3.

Table 2. For types with standard shock absorber (SRM3-\*\*-A, A1, A2), tightening torque of stopper bolt lock nut, shock absorber fixing nut

Tightening torque Model	Stopper bolt square nut N · m	Adjustable stroke plate fixing bolt N · m
SRM3-25-A	4.5 to 6	4.6 to 6
SRM3-32-A	9 to 12	7.5 to 10
SRM3-40-A	22 to 30	22 to 30
SRM3-63-A	110 to 143	55 to 70

Table 3: When (SRM-\*\*-E, EI, E2) with light load type shock absorber, tightening torque of stopper bolt lock nut, shock absorber fixing nut

Tightening torque Model	Stopper bolt square nut N · m	Shock absorber fixing bolt N · m
SRM3-25-E	4.5 to 6	1 to 1.2
SRM3-32-E	4.5 to 6	1 to 1.2
SRM3-40-E	9 to 12	2.3 to 2.8
SRM3-63-E	22 to 30	4.6 to 5.6

#### (4) Adjusting shock absorber

##### ● Standard shock absorber

Absorbed energy of shock absorber is adjusted by changing operational stroke length of shock absorber.

Adjust the shock absorber working stroke by loosening the shock absorber lock nut and turning the shock absorber. After adjusting, tighten the shock absorber fixing nut with the tightening torque shown on table2.

##### ● Light load shock absorber

Tighten a shock absorber fixing bolt with the value on Table 3. When the split thread is deformed by too much torque, split thread can be loosened by screwing a bolt etc. into the thread hole on the following diagram.

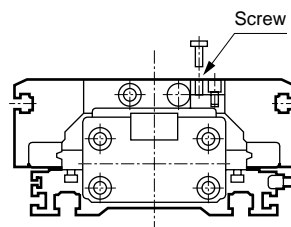

Model	Thread size
SRM3-25	M3
SRM3-32	M3
SRM3-40	M3
SRM3-63	M3

#### ⚠ CAUTION

- Avoid electrical welding after installing the rodless cylinder.

If the current flows into the cylinder and generates sparks between the dust-proof belt and cylinder tube, the dust-proof belt may be damaged.

- If a unit with excessive inertia, etc., is moved, the cylinder may be damaged or faulty operation occur. Use only within the allowable range.

- Do not apply shock or excessive moment on the table.

- Align before connecting to an load with an external guide mechanism.

- Carefully consider connection (floating) so deviation is absorbed. The longer the stroke, the greater the shaft center may deviate.

SCP\*2  
CMK2  
CMA2  
SCM  
SCG  
SCA2  
SCS  
CKV2  
CA/OV2  
SSD  
CAT  
MDC2  
MVC  
SMD2  
MSD\*  
FC\*  
STK  
ULK\*  
JSK/M2  
JSG  
JSC3  
USSD  
USC  
JSB3  
LMB  
STG  
STS L  
LCS  
LCG  
LCM  
LCT  
LCY  
STR2  
UCA2  
HCM  
HCA  
SRL3  
SRG3  
SRM3  
SRT3  
MRL2  
MRG2  
SM-25  
CAC4  
UCAC2  
RCC2  
MFC  
SHC  
GLC  
Ending

Rodless type  
High precision guided rodless cylinder

SCP\*2  
CMK2  
CMA2  
SCM  
SCG  
SCA2  
SCS  
CKV2  
CA/OV2  
SSD  
CAT  
MDC2  
MVC  
SMD2  
MSD\*  
FC\*  
STK  
ULK\*  
JSK/M2  
JSG  
JSC3  
USSD  
USC  
JSB3  
LMB  
STG  
STS L  
LCS  
LCG  
LCM  
LCT  
LCY  
STR2  
UCA2  
HCM  
HCA  
SRL3  
SRG3  
**SRM3**  
SRT3  
MRL2  
MRG2  
SM-25  
CAC4  
UCAC2  
RCC2  
MFC  
SHC  
GLC  
Ending

■ Check that moment, including inertia generated when moving or stopping the load, does not exceed the allowable load, or damage may result. If this value is exceeded, the product is damaged.

(When the overhang is large)

● If overhang is large and the cylinder is stopped at both ends with the piston, the bending moment functions due to load inertia even within internal cushion energy absorption.

If kinetic energy is large and an external cushion, etc., is used, try contact with the work-piece center of gravity when possible.

(When using an external stopper)

● When selecting an external stopper, consider the bending moment generated by cylinder thrust.

● Moment that functions when stopping with external stopper

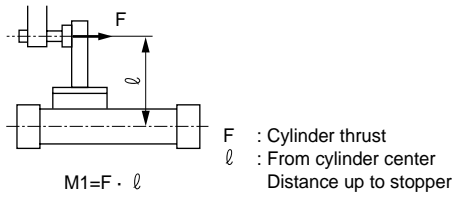

■ Do not make a nick and a scratch etc., that deteriorates flatness on main body (tube) fixing surface and table mounting surface.

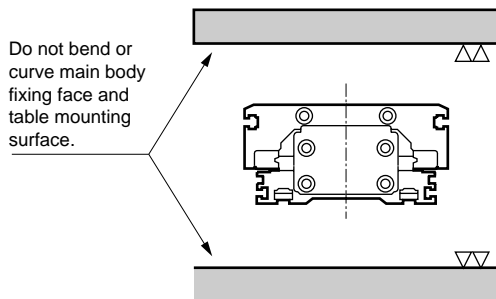

■ Piping port position and operating direction.

● Option symbol (Blank, R, B, T)

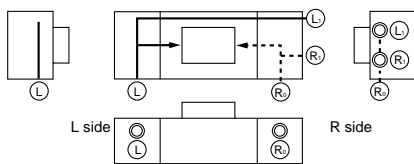

Ⓡ indicates Ⓡ side pressurized port and Ⓛ indicates Ⓛ side pressurized port. Before shipping, all plugs other than 1 each at Ⓡ and Ⓛ are sealed with plugs. Piping to other ports becomes possible by removing plug. However, bottom side piping is not possible. Select options (D, S) if such connection is necessary.

- Ⓛ ports are available only in  $\phi 25$ ,  $\phi 32$ ,  $\phi 40$ .
- Ⓡ ports are not available for  $\phi 63$ .

● Option symbols (D, S) (bottom piping)

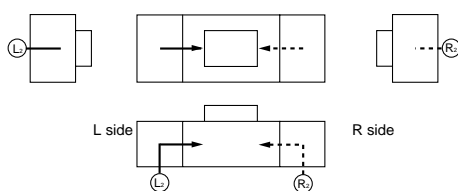

Ⓡ indicates R side pressurized port and Ⓛ indicates L side pressurized port. There are no ports other than Ⓡ or Ⓛ, so pipes cannot be connected.

■ Main body mounting

SRM3 can be mounted on 2 directions as shown below. T groove enables this flexible installation from side direction. In that case, if horizontal adjustment is possible, installation will be much easier.

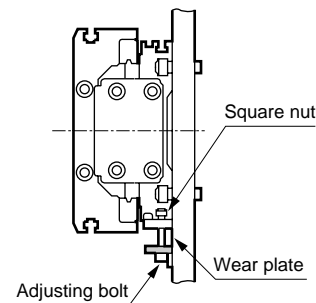
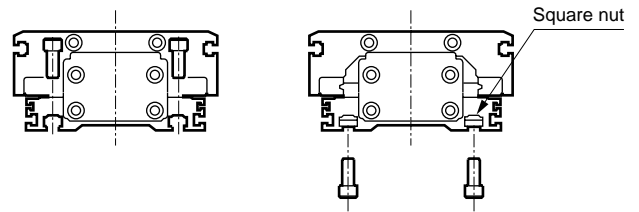

■ T groove and square nut

For SRM3, T groove for square nut is provided as the following diagram. Square nuts on the table below are attached as accessory at shipment.

● Eight square nuts included.

Model	Square nut	
SRM3-25	M4	M5
SRM3-32	M4	M6
SRM3-40	M4	M8
SRM3-63	M5	M10

● The following dimensions are recommended for the T groove bolt length  $R_{mm}$

Model	WA	WB	WC
SRM3-25	M4 $l = t + 6$	—	M5 $l = t + 6$
SRM3-32	M4 $l = t + 6$	—	M6 $l = t + 8$
SRM3-40	M4 $l = t + 6$	M4 $l = t + 6$	M8 $l = t + 10$
SRM3-63	M5 $l = t + 7$	M5 $l = t + 7$	M10 $l = t + 12$

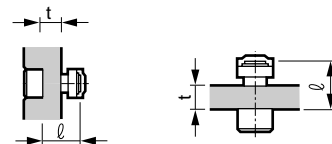
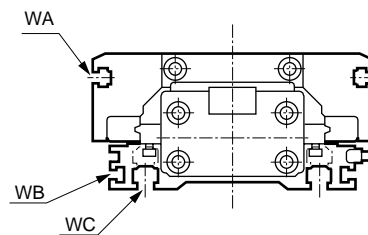

[Example of using table T groove]

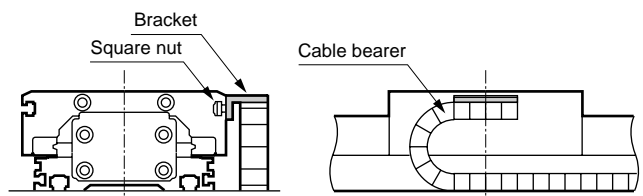

■The CKD shock absorber is treated as a consumable.

Replace the shock absorber if energy absorption performance drops or if movement is no longer smooth.

## 2. Position locking type SRM3-Q

### ⚠ WARNING

#### ■How to adjust stroke adjustment unit

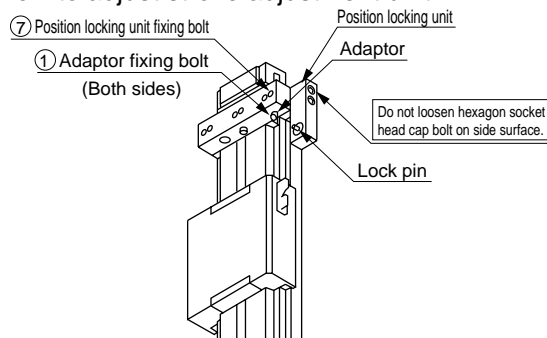

Loosen ⑦ position locking unit fixing bolt shown above, and adjust the stroke. Do not loosen the hexagon socket head cap screw on the side view above, because the position of position locking unit lock pin deviates.

●Position locking unit can be moved by loosening the adaptor fixing bolt.

Select shock absorber (A, A1, A2, E, E1, E2) in this case. If the stroke is finely adjusted with the shock absorber, the position locking unit deviates and the position cannot be completely locked. Finely adjust stroke with the adapter fixing bolt.

●After moving to the required position, tighten and fix the adaptor fixing bolt using the values below. The position locking unit may deviate if the bolt is not tightened to these values.

●Before setting the load, make sure that the locking mechanism functions correctly.

Model	(1) Adaptor fixing bolt	Tightening torque
	(7) Position locking unit fixing bolt	Tightening torque (N · m)
SRM3-Q-25		6.2 to 7.6
SRM3-Q-32		6.2 to 7.6
SRM3-Q-40		10.4 to 12.8
SRM3-Q-63		19.4 to 23.8

#### ■Piping

●Piping is required for the position locking unit.

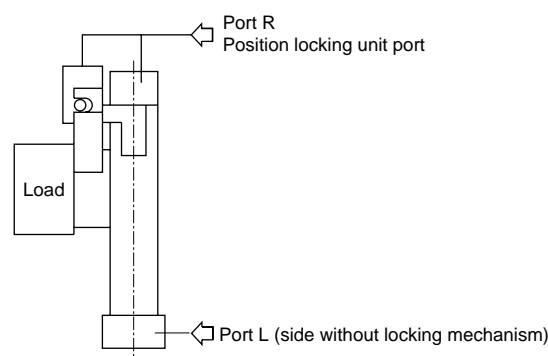

●Branch piping to the rodless cylinder R side using a tee union, etc., and pipe to the position locking unit with similar piping.

●If the piping on the side where the locking mechanism is provided is long and thin, or if the speed controller is separated from the cylinder port, the exhaust speed will drop and it may take longer for the lock to be applied. This may also occur if the silencer on the valve's EXH port is clogged.

■Supply pressure above the minimum working pressure to the position locking unit port.

#### ■Manual release

●Release the position locking pin with a rod-shaped object. Supply pressure to port L to check that load is not applied to the locking mechanism before releasing the lock.

●If both ports R and L are exhausted and pressure is supplied to port R while the piston is locked, the lock is released and the table may suddenly move, creating a hazard.

#### ■Valves

●If the cylinder is held while pressure is applied on the locking mechanism, the locking pin may dislocate and create a very hazard. Do not use a 3-position closed center or P/A/B connection valve.

●If back pressure is applied while locked, the lock may be released. Use a discrete valve, or use an individual exhaust manifold.

●If lowering speed is to be increased with the quick exhaust valve, the cylinder may move out faster than the lock pin and prevent the locking pin from being released correctly. Do not use quick exhaust valves on position locking cylinders.

SCP*2
CMK2
CMA2
SCM
SCG
SCA2
SCS
CKV2
CA/OV2
SSD
CAT
MDC2
MVC
SMD2
MSD*
FC*
STK
ULK*
JSK/M2
JSG
JSC3
USSD
USC
JSB3
LMB
STG
STS L
LCS
LCG
LCM
LCT
LCY
STR2
UCA2
HCM
HCA
SRL3
SRG3
<b>SRM3</b>
SRT3
MRL2
MRG2
SM-25
CAC4
UCAC2
RCC2
MFC
SHC
GLC

Ending

Rodless type  
High precision guided rodless cylinder



SCP*2
CMK2
CMA2
SCM
SCG
SCA2
SCS
CKV2
CA/OV2
SSD
CAT
MDC2
MVC
SMD2
MSD*
FC*
STK
ULK*
JSK/M2
JSG
JSC3
USSD
USC
JSB3
LMB
STG
STS L
LCS
LCG
LCM
LCT
LCY
STR2
UCA2
HCM
HCA
SRL3
SRG3
<b>SRM3</b>
SRT3
MRL2
MRG2
SM-25
CAC4
UCAC2
RCC2
MFC
SHC
GLC
Ending

## During Use & Maintenance

### 1. Common

#### ⚠ CAUTION

■For SRM3 series guide part, the adequate pressurizing adjustment is conducted at shipment. Do not do pressurizing adjustments while in use.

■For SRM3 Series guide, when regular use, apply lithium grease every travel distance 100km (approximate 6 months).

Grease guns are recommended.

THK: Grease gun unit MG70

P shaped tip.

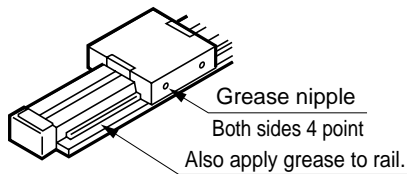

### 2. Position locking type SRM3-Q

#### ⚠ WARNING

■For safety purposes, prevent the load from dropping under its own weight during maintenance.

■When using the cylinder with air cushion, if the air cushion needle on the lock mechanism side is tightened too much, the piston could bounce at the stroke end causing the lock lever and lock pin to collide and damage the locking mechanism. If the air cushion needle is opened too far, the piston could spring back at the stroke end and cause similar damage. Adjust the air cushion needle so that the piston does not bounce.

When stopping with an external shock absorber, etc., adjust in the same way to prevent bouncing.

Regularly (once/twice a year) check that the holding section is not damaged by this symptom.

#### ⚠ CAUTION

■If the locking mechanism has been manually operated, check and then return it manually to the original position. Do not use manual override except during adjustment.

■Release the lock when installing or adjusting the cylinder. The lock could be damaged if the cylinder is installed while the lock is applied.

■Do not use multiple cylinders synchronized. Do not move more than one workpiece using more than two cylinders with position locking mechanism simultaneously. One of the cylinder may become unable to unlock.

■Use the speed control valve with meter-out control. Locks may not be released during meter-in control.

■Always use up to the stroke end of the side with the lock. If the cylinder's piston does not reach the stroke end, the lock may not be applied or may not be released.

■Apply grease to sliding section of lock lever periodically.





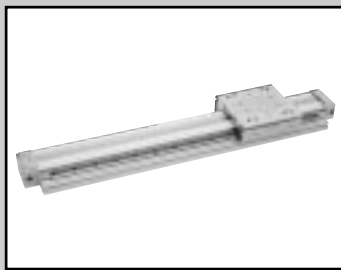

High precision guided rodless cylinder

# Double acting SRM3 Series

## Double acting position locking SRM3-Q Series

● Bore size:  $\varnothing 25$ ,  $\varnothing 32$ ,  $\varnothing 40$ ,  $\varnothing 63$

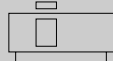

### Specifications

Descriptions	SRM3				SRM3-Q			
	Standard type/with switch				Position locking type/with switch			
Bore size mm	$\varnothing 25$	$\varnothing 32$	$\varnothing 40$	$\varnothing 63$	$\varnothing 25$	$\varnothing 32$	$\varnothing 40$	$\varnothing 63$
Actuation	Double acting				Double acting position locking type			
Working fluid	Compressed air							
Max. working pressure MPa	0.7							
Min. working pressure MPa	0.15		0.1		0.15		0.1	
Withstanding pressure MPa	1.05							
Ambient temperature $^{\circ}\text{C}$	5 to 60							
Port size	Cylinder body port	Rc1/8	Rc1/4	Rc3/8	Rc1/8	Rc1/4	Rc3/8	
	Port for position locking	-			Rc1/8			
Stroke tolerance mm	$^{+0.20}_{-0}$ (to 1000)				$^{+0.25}_{-0}$ (to 2000)			
Working piston speed mm/s	50 to 1500 (Note 1, Note 2)							
Cushion	Air cushion							
Lubrication	Not required							
Repeatability mm	-		$\pm 0.03$					
Position locking mechanism	-				Installation on guard R			
Holding force N					Maximum thrust x 0.7			

Note 1: Working piston speed when using with common port piping, may vary depending on stroke length, Consult with CKD.

Note 2:(1) When operating at speed from 500 to 1500mm/s, the speed rush into position locking mechanism should be 500mm/s or less. If the speed is faster, decelerate the speed.

(2) For deceleration method, install an external shock absorber or a deceleration circuit etc.

(3) Apply release to sliding section of lock lever regularly.

### Allowable energy absorption

Bore size (mm)	Cushioned		No cushion	With shock absorber (initial setpoint)	
	Allowable energy absorption (J)	Cushion mm stroke (mm)	Allowable energy absorption (J)	Absorbed energy (J)	Valid mm stroke (mm)
$\varnothing 25$	1.40	20.9	0.015	10	9
$\varnothing 32$	2.57	23.5	0.030	18	13
$\varnothing 40$	4.27	23.9	0.050	50	16.5
$\varnothing 63$	17.4	29.6	0.138	86	21

### Stroke length

Bore size (mm)	Standard stroke length (mm)	Max. stroke length (mm)	Min. stroke length (mm)
$\varnothing 25$ , $\varnothing 32$	200, 300, 400, 500, 600, 700, 800, 900, 1000	1000	50
$\varnothing 40$ , $\varnothing 63$	200, 300, 400, 500, 600, 700, 800, 900, 1000, 1100, 1200, 1300, 1400, 1500, 1600, 1700, 1800, 1900, 2000	2000	80

Note: Custom stroke length is available in 1mm increments.

### Switch quantity and min. stroke length (mm)

Switch quantity	1		2		3		4		5		6		7		8		9	
Switch model no.	T*V	T*H	T*V	T*H	T*V	T*H	T*V	T*H	T*V	T*H	T*V	T*H	T*V	T*H	T*V	T*H	T*V	T*H
Bore size (mm)																		
$\varnothing 25$	50	50	50	50	90	100	135	150	180	200	225	250	270	300	315	350	360	400
$\varnothing 32$	50	50	50	50	90	100	135	150	180	200	225	250	270	300	315	350	360	400
$\varnothing 40$	80	80	80	80	90	100	135	150	180	200	225	250	270	300	315	350	360	400
$\varnothing 63$	80	80	80	80	90	100	135	150	180	200	225	250	270	300	315	350	360	400

### Switch specifications

● 1 color/2 color indicator/strong magnetic field proof

\*The T0/T5 switch can be used with 220 VAC . Consult with CKD for working conditions.

Descriptions	Proximity 2 wire		Proximity 3 wire		Reed 2 wire						Proximity 2 wire	
	T2YH/T2YV	T2WH/T2WV	T3YH/T3YV	T3WH/T3WV	T0H/T0V		T5H/T5V		T8H/T8V		T2YD	
Applications	PLC dedicated		PLC and relay		PLC and relay		PLC, relay, serial connection IC circuit (without indicator light)		PLC and relay		PLC dedicated	
Output method	-		NPN output		-							
Power voltage	-		10 to 28 VDC		-							
Load voltage	10 to 30 VDC	24 VDC ±10%	30 VDC or less		12/24 VDC	110 VAC	5/12/24 VDC	110 VAC	12/24 VDC	110 VAC	220 VAC	24 VDC ±10%
Load current	5 to 20mA (Note 1)		50mA or less		5 to 50mA	7 to 20mA	50mA or less	20mA or less	5 to 50mA	7 to 20mA	7 to 10mA	5 to 20mA
Light	Red/green LED (ON lighting)		Red/green LED (ON lighting)		LED (ON lighting)		Without indicator light		LED (ON lighting)		Red/green LED (ON lighting)	
Leakage current	1mA or less		10µA or less		0mA						1mA or less	

Note 1: Cylinder switch cannot be changed from reed switch to proximity switch or vice versa after shipment.

When cylinder switch is not specified (blank), cylinder main body is shipped with reed switch specifications.

### Cylinder weight

Unit: kg

Bore size (mm)	Weight when stroke length 0mm.			Additional weight per St = 100mm
	Basic type (SRM3)	Position locking type basic type (SRM3-Q)	Weight per switch (Including bracket)	
ø25	2.4	2.9	0.02	0.59
ø32	3.3	4.2		0.72
ø40	4.8	6.0		1.20
ø63	15.1	17.8		1.99

SCP*2
CMK2
CMA2
SCM
SCG
SCA2
SCS
CKV2
CA/OV2
SSD
CAT
MDC2
MVC
SMD2
MSD*
FC*
STK
ULK*
JSK/M2
JSG
JSC3
USSD
USC
JSB3
LMB
STG
STS L
LCS
LCG
LCM
LCT
LCY
STR2
UCA2
HCM
HCA
SRL3
SRG3
<b>SRM3</b>
SRT3
MRL2
MRG2
SM-25
CAC4
UCAC2
RCC2
MFC
SHC
GLC
Ending

Rodless type  
High precision guided rodless cylinder

## How to order

Without switch



With switch

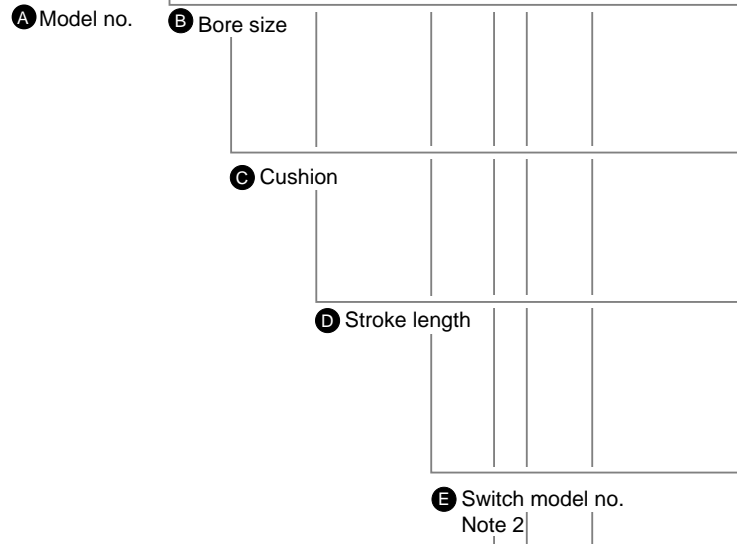

### Note on model no. selection

- Note 1: Refer to page 2116 for min. stroke with switch.
- Note 2: Switches not listed on **E** are also available as custom order. Refer to Ending 1.
- Note 3: The adjustable full stroke bracket can not be installed later. However option "A3" will have a mounting plate nut installed that will allow adjustable full stroke bracket to be installed later.
- Note 4: An adjustable full-stroke bracket is provided on R side as a standard part for position locking. When "A1" or "E1" is specified, a shock absorber is added on R side only. When "A" is specified, a position locking, an adjustable full-stroke, and a shock absorber are provided on R side, while an adjustable full-stroke and a shock absorber are provided on L side. (The following diagram)
- Note 5: Copper and PTFE free as standard

<Example of model number>  
SRM3-25B-500-T0H-R-A

Model: Rodless cylinder high precision guided

- A** Model no. : Standard type
- B** Bore size :  $\varnothing 25\text{mm}$
- C** Cushion : Both sides cushioned
- D** Stroke length : 500mm
- E** Switch model no. : Reed switch TOH
- F** Switch quantity : One on R side
- G** Option : Adjustable full-stroke both sides, standard with shock absorber

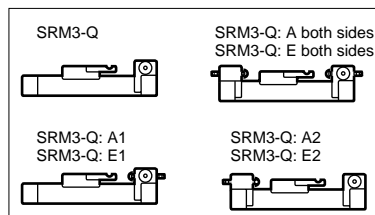

Symbol	Descriptions
<b>A Model no.</b>	
SRM3	Standard type
SRM3-Q	Position locking type

<b>B Bore size (mm)</b>	
25	$\varnothing 25$
32	$\varnothing 32$
40	$\varnothing 40$
63	$\varnothing 63$

<b>C Cushion</b>	
B	Both sides cushioned
R	R side cushioned
L	L side cushioned
N	No cushion

<b>D Stroke length (mm)</b>		
Bore size	Stroke length Note 1	Custom stroke length
$\varnothing 25$	50 to 1000	By 1 mm increment
$\varnothing 32$	50 to 1000	
$\varnothing 40$	80 to 2000	
$\varnothing 63$	80 to 2000	

<b>E Switch model no.</b>				
Lead wire	Lead wire	Contact	Indicator	Lead Line
Axial	Radial			
T0H*	T0V*	Reed	1 color indicator type	2-wire
T5H*	T5V*		Without indicator light	
T8H*	T8V*		1 color indicator type	2-wire
T2WH*	T2WV*	Proximity	2 color indicator type	2-wire
T2YH*	T2YV*			
T3WH*	T3WV*		Strong magnetic field proof switch	2-wire
T3YH*	T3YV*			
T2YD*	-			
T2YDT*	-			

<b>*Lead wire length</b>	
Blank	1m (standard)
3	3m (option)
5	5m (option)

<b>*Select only when not selecting a model no.</b>	
C0	Reed switch
C1	Proximity switch

<b>F Switch quantity</b>	
R	One on R side
L	One on L side
D	2
T	3
4	4 pieces (fill in quantity for 4 or more)

<b>G Option</b>		Bore size ( $\varnothing$ )				
		25	32	40	63	
A	Adjustable full-stroke	Both sides with shock absorber	●	●	●	●
A1		Shock absorber provided at R side	●	●	●	●
A2		Shock absorber provided at L side	●	●	●	●
A3		Bracket can be installed later	●	●	●	●
E	Adjustable full-stroke	Both sides with light load shock absorber	●	●	●	●
E1		Light load shock absorber provided at R side	●	●	●	●
E2		Light load shock absorber provided at L side	●	●	●	●
Blank	Port position	F (standard)	●	●	●	●
R		R (common port)	●	●	●	●
B		F	●	●	●	●
T		R (common port)	●	●	●	●
D		D	●	●	●	●
S	Cushion needle position	D	●	●	●	●
		F (standard)	●	●	●	●

### How to order switch

● Only switch body

**SW** - **T0H**

→ Switch model no.  
(Previous page section(E))

### How to order discrete shock absorber

Model	Discrete shock absorber model no.	
	Standard type (-A)	Light load type (-E)
SRM3-25	NCK-00-1.2	NCK-00-0.7-C
SRM3-32	NCK-00-2.6	NCK-00-1.2
SRM3-40	NCK-00-7	NCK-00-2.6
SRM3-63	NCK-00-12	NCK-00-7

### Repair parts model no.

**SRM3** - **40** K - **200**

Bore size  
(Previous page section(B))      Stroke length  
(Previous page section(D))

### Full stroke adjustment bracket model no. (For option symbol A3)

**SRM3** - **40** - \*

Bore size  
(Previous page section(B))

(Specify the A1, E1 at the \*section.)

SCP*2
CMK2
CMA2
SCM
SCG
SCA2
SCS
CKV2
CA/OV2
SSD
CAT
MDC2
MVC
SMD2
MSD*
FC*
STK
ULK*
JSK/M2
JSG
JSC3
USSD
USC
JSB3
LMB
STG
STS L
LCS
LCG
LCM
LCT
LCY
STR2
UCA2
HCM
HCA
<b>SRL3</b>
<b>SRG3</b>
<b>SRM3</b>
<b>SRT3</b>
<b>MRL2</b>
<b>MRG2</b>
<b>SM-25</b>
CAC4
UCAC2
RCC2
MFC
SHC
GLC
Ending

Rodless type  
High precision guided rodless cylinder

## Internal structure drawing and parts list (ø25 to ø63)

For SRM3-63

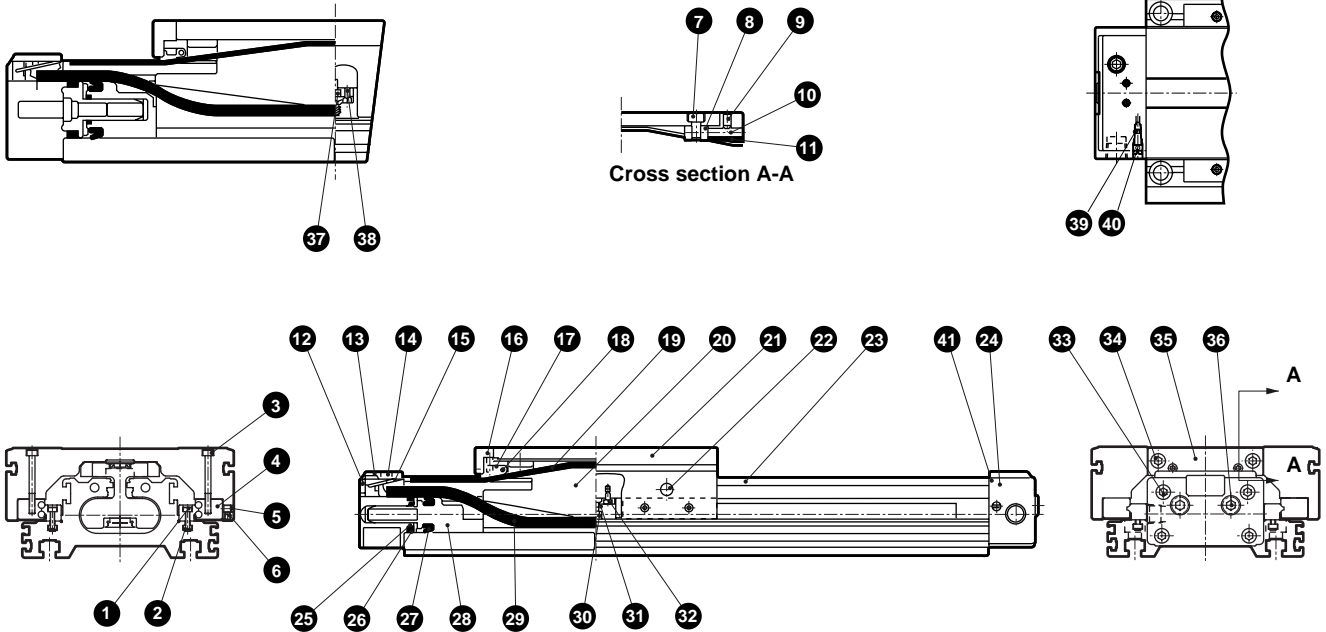

No.	Parts name	Material	Remarks	No.	Parts name	Material	Remarks
1	Hexagon socket head cap bolt	Alloy steel	Blackening	22	Grease nipple (ball cup)		
2	Nut rail	Steel	Blackening	23	Cylinder tube	Aluminum alloy	Alumite
3	Hexagon socket head cap bolt	Alloy steel	Blackening	24	Guard (R) assembly		
4	High precision guide	Steel		25	Cushion packing seal	Urethane rubber	
5	Hexagon socket set screw	Alloy steel	Galvanizing	26	Cylinder gasket	Nitrile rubber	
6	Hexagon socket set screw	Alloy steel	Galvanizing	27	Piston packing seal	Nitrile rubber	
7	Hexagon socket head cap bolt	Alloy steel	Galvanizing	28	Piston	Polyacetal resin	
8	Yoke holder	Steel	Blackening	29	Seal belt	Urethane rubber	
9	Hexagon socket set screw	Alloy steel	Galvanizing	30	Magnet	Special alloy	
10	Hexagon socket set screw	Alloy steel	Galvanizing	31	Magnet case	Polyamide	
11	Dust wiper	Polyacetal resin		32	Hexagon socket bolt	SUS	
12	Belt cover	Polyamide		33	Hexagon socket bolt	Alloy steel	Galvanizing
13	Guard (L) assembly			34	Hexagon socket bolt	Alloy steel	Galvanizing
14	Hexagon socket set screw	Alloy steel	Galvanizing	35	Table cover	Steel	Galvanizing
15	Belt spacer	Steel	Galvanizing	36	Plug	Steel	Galvanizing
16	Spring	Steel	Blackening	37	Spacer	Aluminum alloy	
17	Belt tension	Polyacetal resin		38	Hexagon socket bolt	SUS	
18	Parallel pin	Steel	Galvanizing	39	Needle gasket	Nitrile rubber	
19	Dust-proof belt	Stainless steel + nitrile rubber		40	Cushion needle	Steel	Galvanizing
20	Yoke	Aluminum alloy	Alumite	41	Common port, O ring	Nitrile rubber	
21	Table	Aluminum alloy	Alumite				

### Repair parts list

No. and parts name Bore size (mm)	Kit No.	Repair parts number
ø25	SRM3-25K-*	
ø32	SRM3-32K-*	11 19 25 26
ø40	SRM3-40K-*	27 29 39 41
ø63	SRM3-63K-*	

● Note 1: Specify the kit no. when placing an order. Specify the stroke length for "\*".

### Internal structure drawing and parts list: with shock absorber (ø25 to ø63)

● Adjustable full-stroke and standard with shock absorber (SRM3-\*\*-\*\*\*-A)

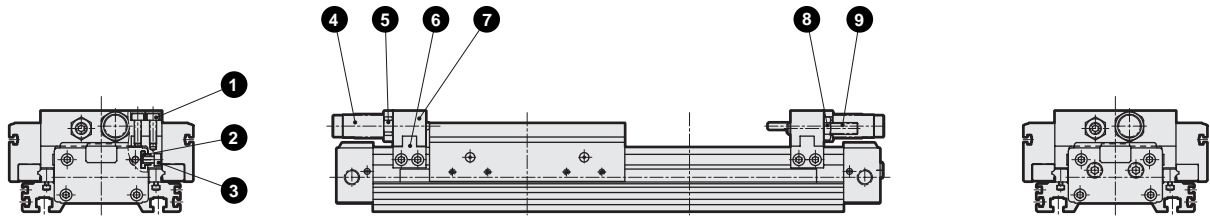

● Adjustable full-stroke and light load shock absorber (SRM3-\*\*-\*\*\*-E)

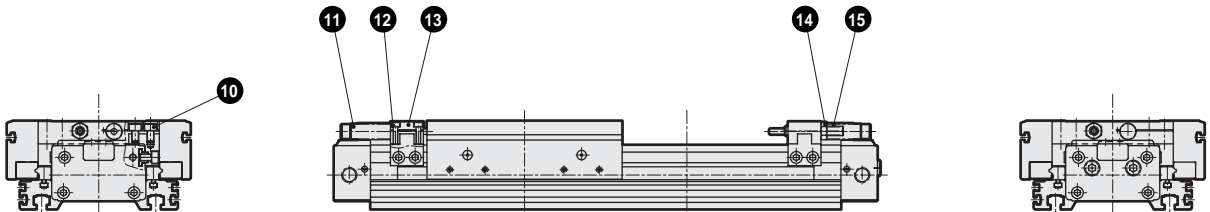

No.	Parts name	Material	Remarks	No.	Parts name	Material	Remarks
1	Hexagon socket head cap bolt	Alloy steel	Galvanizing	9	Hexagon socket set screw	Alloy steel	Galvanizing
2	Square nut	Steel	Blackening	10	Hexagon socket bolt	Alloy steel	Galvanizing
3	Hexagon socket head cap bolt	Alloy steel	Galvanizing	11	Shock absorber		
4	Shock absorber			12	Hexagon socket bolt	Alloy steel	Galvanizing
5	Square nut	Steel	Galvanizing	13	Plate (3)	Aluminum alloy	Alumite
6	Adaptor	Steel	Galvanizing	14	Square nut	Steel	Galvanizing
7	Plate (1)	Aluminum alloy	Alumite	15	Hexagon socket set screw	Alloy steel	Galvanizing
8	Square nut	Steel	Galvanizing				

### Internal structure drawing and parts list: position locking (ø25 to ø63)

● Position locking (SRM3-Q)

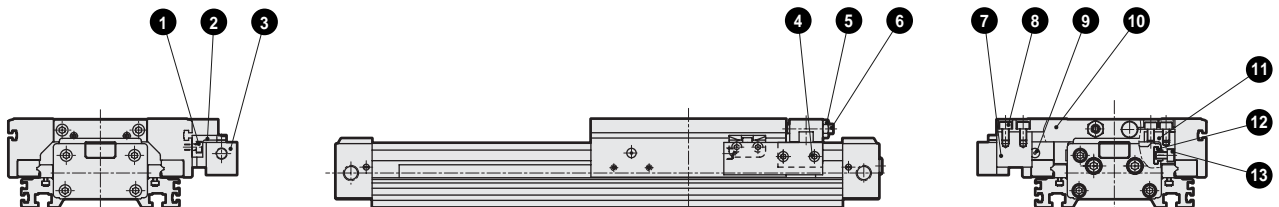

● Position locking, adjustable full-stroke and light load shock absorber (SRM3-Q-\*\*-\*\*\*-E1)

● Position locking, adjustable full-stroke and standard with shock absorber (SRM3-Q-\*\*-\*\*\*-A1)

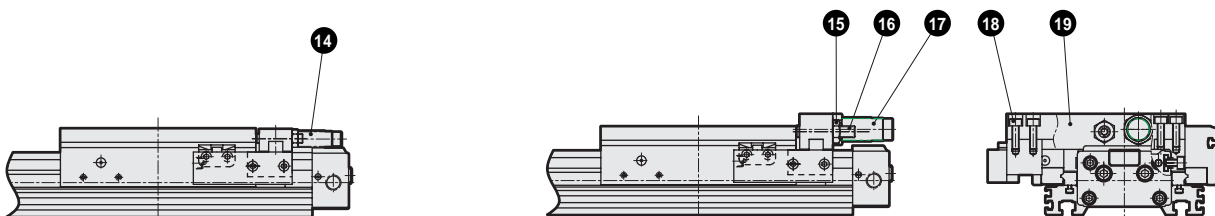

No.	Parts name	Material	Remarks	No.	Parts name	Material	Remarks
1	Hexagon socket head cap bolt	Alloy steel	Galvanizing	11	Adaptor	Steel	Galvanizing
2	Lock lever	Steel	Galvanizing	12	Square nut	Steel	Blackening
3	Position locking unit assembly			13	Hexagon socket bolt	Alloy steel	Galvanizing
4	Hexagon socket bolt	Alloy steel	Galvanizing	14	Shock absorber		
5	Square nut	Steel	Galvanizing	15	Square nut	Steel	Galvanizing
6	Hexagon socket set screw	Alloy steel	Galvanizing	16	Hexagon socket set screw	Alloy steel	Galvanizing
7	Installation block	Aluminum alloy	Alumite	17	Shock absorber		
8	Hexagon socket bolt	Alloy steel	Galvanizing	18	Hexagon socket bolt	Alloy steel	Galvanizing
9	Grease nipple (ball cup)	(SRM-Q-25 not available)		19	Plate (2)	Aluminum alloy	Alumite
10	Plate (4)	Aluminum alloy	Alumite				

SCP\*2  
CMK2  
CMA2  
SCM  
SCG  
SCA2  
SCS  
CKV2  
CA/OV2  
SSD  
CAT  
MDC2  
MVC  
SMD2  
MSD\*  
FC\*  
STK  
ULK\*  
JSK/M2  
JSG  
JSC3  
USSD  
USC  
JSB3  
LMB  
STG  
STS L  
LCS  
LCG  
LCM  
LCT  
LCY  
STR2  
UCA2  
HCM  
HCA  
SRL3  
SRG3  
SRM3  
SRT3  
MRL2  
MRG2  
SM-25  
CAC4  
UCAC2  
RCC2  
MFC  
SHC  
GLC  
Ending

Rodless type  
High precision guided rodless cylinder

## Dimensions



● SRM3 with cylinder switch SRM3-\*\*-\*\*\*-\*\*\*-T\*V\*  
(Radial lead wire)

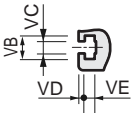
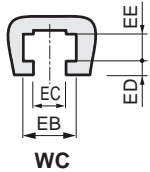
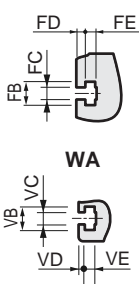
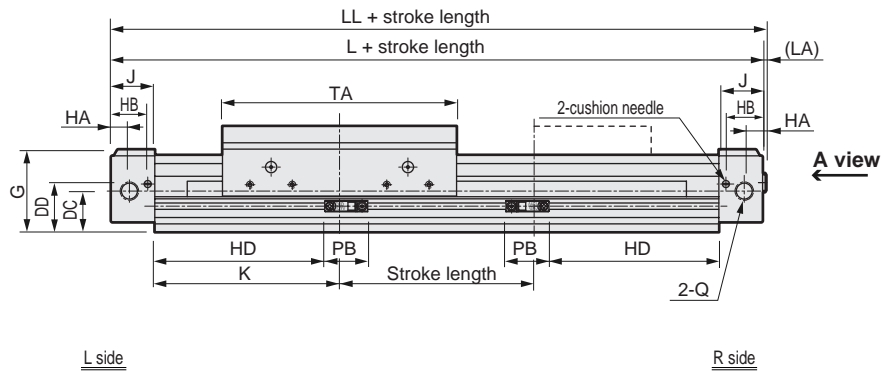
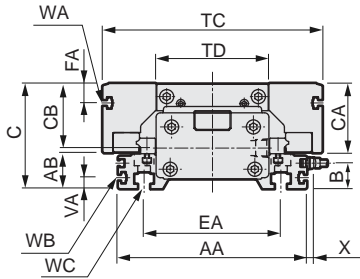
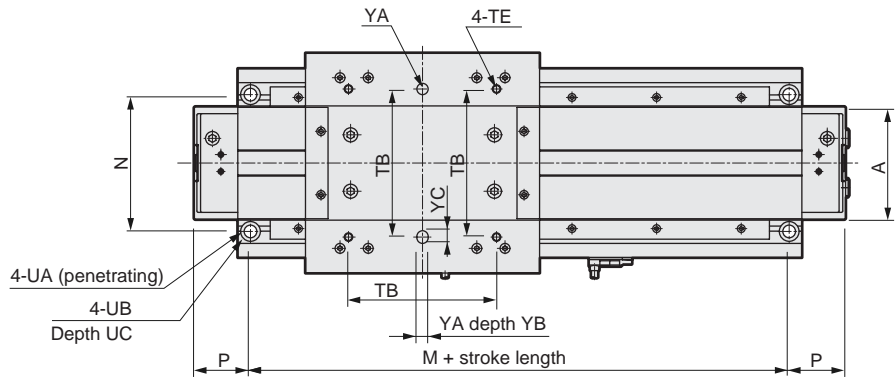

WB

Note: SRM3-25, 32 does not have WB.

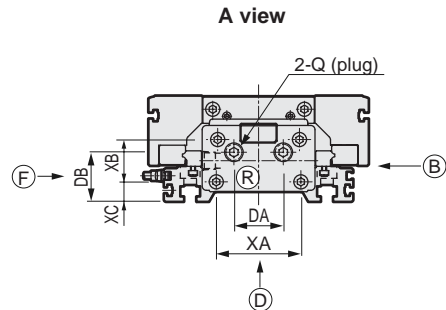

Symbol	A	AA	AB	B	C	CA	CB	DA	DB	DC	DD	EA	EB	EC	ED
Bore size (mm)															
ø25	53	102	18	11.3	57	39	37	26	22	20	21.9	71	9.5	5.5	2.5
ø32	66	116	20	13.3	62	41.5	39.5	27	25	22.5	25.5	80	11	6.6	2.5
ø40	80	134	25	18.3	75	49.5	46	35	35	29	34	97	14.5	9	3.5
ø63	118	188	31.5	24.8	100	68	62.5	39	44.5	37.5	45.5	140	18	11	4
Symbol	EE	FA	FB	FC	FD	FE	G	HA	HB	J	K	L	LA	LL	
Bore size (mm)															
ø25	4.5	10	8.5	4.5	3	3.7	43.5	7.5	20	24	98	244	2	246	
ø32	6	10	8.5	4.5	3	3.7	47.5	10	23.5	28	106	268	2.5	270.5	
ø40	7.5	14	8.5	4.5	3	3.7	58.5	13	26	31	131	324	2.5	326.5	
ø63	9	20	9.5	5.5	3	4.5	76.5	15	32	39	187	452	2.5	454.5	

Note 1: Cylinder switch cannot be changed from reed switch to proximity switch or vice versa after shipment.  
When cylinder switch is not specified (blank), cylinder main body is shipped with reed switch specifications.



## Dimensions

- SRM3 with cylinder switch SRM3-\*\*-\*\*-\*\*\*-T\*H\*  
(Axial lead wire)

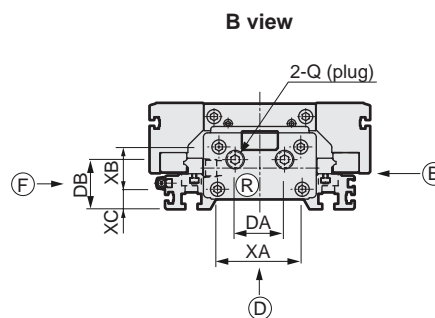
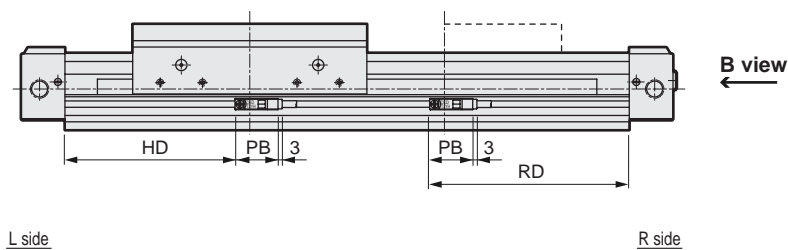
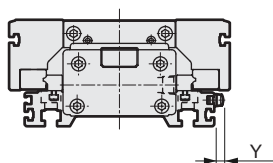

Symbol	LL	M	N	P	Q	TA	TB	TC	TD	TE	UA	UB								
<b>Bore size (mm)</b>																				
ø25	246	182	71	31	Rc1/8	118	75	112	61	M5 depth 12	5.5	9.5 spot face depth 6.5								
ø32	270.5	196	80	36	Rc1/4	132	85	128	65	M6 depth 13	6.6	11 spot face depth 6.5								
ø40	326.5	244	97	40	Rc1/4	166	105	156	81	M6 depth 15	9	14 spot face depth 8.5								
ø63	454.5	350	140	51	Rc3/8	250	160	224	118	M8 depth 20	11	17.5 spot face depth 10.5								
<b>Symbol</b>	<b>VA</b>	<b>VB</b>	<b>VC</b>	<b>VD</b>	<b>VE</b>	<b>XA</b>	<b>XB</b>	<b>XC</b>	<b>YA</b>	<b>YC</b>										
<b>Bore size (mm)</b>																				
ø25	-	-	-	-	-	38	23	8.5	6 <sup>+0.07</sup> / <sub>-0.02</sub> depth 6	7										
ø32	-	-	-	-	-	48	25	10	6 <sup>+0.07</sup> / <sub>-0.02</sub> depth 6	7										
ø40	8	8.5	4.5	2	3.7	60	30	14	8 <sup>+0.07</sup> / <sub>-0.02</sub> depth 8	9										
ø63	10	9.5	5.5	2.5	4.5	96	42	16.5	10 <sup>+0.07</sup> / <sub>-0.02</sub> depth 10	12										
<b>Symbol</b>	<b>With switch</b>																			
<b>Bore size (mm)</b>	<b>T0H/V, T5H/V</b>					<b>T1H/V, T2Y*H/V, T3Y*H/V, T2YD</b>					<b>T8H/V</b>					<b>T2WH/V, T3WH/V</b>				
	RD	HD	X	Y	PB	RD	HD	X	Y	PB	RD	HD	X	Y	PB	RD	HD	X	Y	PB
ø25	107.5	88.5	4	0.5	22.5	108.5	87.5	9.3 (14.5)	6.3 (11.5)	30.5 (29.5)	102.5	81.5	9.3	6.3	30.5	105.5	90.5	4	0.5	22.5
ø32	115.5	96.5	4	0.5	22.5	116.5	95.5	9.3 (14.5)	6.3 (11.5)	30.5 (29.5)	110.5	89.5	9.3	6.3	30.5	113.5	98.5	4	0.5	22.5
ø40	140.5	121.5	4	0.5	22.5	141.5	120.5	9.3 (14.5)	6.3 (11.5)	30.5 (29.5)	135.5	114.5	9.3	6.3	30.5	138.5	123.5	4	0.5	22.5
ø63	196.5	177.5	4	0.5	22.5	197.5	176.5	9.3 (14.5)	6.3 (11.5)	30.5 (29.5)	191.5	170.5	9.3	6.3	30.5	194.5	179.5	4	0.5	22.5

Note 1: ( ) inside is for T1H/V, strong magnetic field proof.

SCP\*2  
CMK2  
CMA2  
SCM  
SCG  
SCA2  
SCS  
CKV2  
CA/OV2  
SSD  
CAT  
MDC2  
MVC  
SMD2  
MSD\*  
FC\*  
STK  
ULK\*  
JSK/M2  
JSG  
JSC3  
USSD  
USC  
JSB3  
LMB  
STG  
STS L  
LCS  
LCG  
LCM  
LCT  
LCY  
STR2  
UCA2  
HCM  
HCA  
SRL3  
SRG3  
SRM3  
SRT3  
MRL2  
MRG2  
SM-25  
CAC4  
UCAC2  
RCC2  
MFC  
SHC  
GLC  
Ending

Rodless type  
High precision guided rodless cylinder

## Dimensions

● Adjustable full-stroke and standard with shock absorber (SRM3-\*\*-\*\*\*-A)

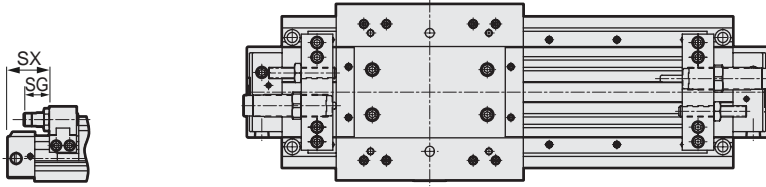

Note: A SRM3-25-A shock absorber is entered an inside of a guard.

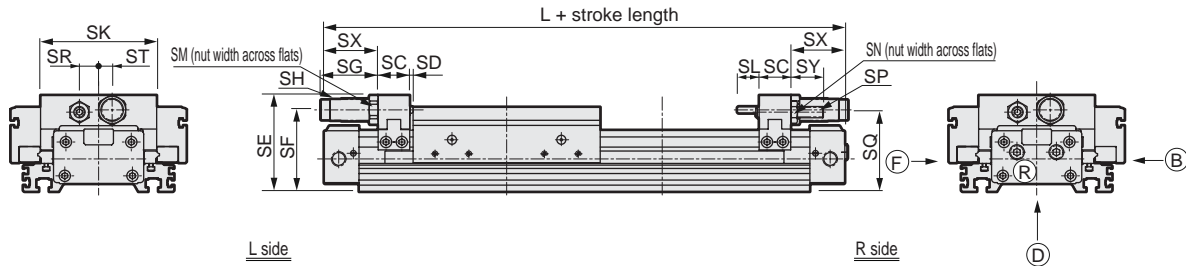

● Adjustable full-stroke with light load shock absorber (SRM3-\*\*-\*\*\*-E)

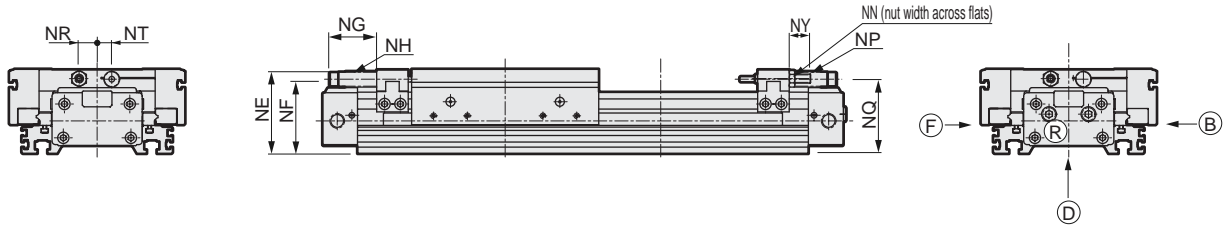

Symbol	SC	SD	SE	SF	SG			SH			SK	SL	SM	SN	SP	SQ	SR	ST
Bore size (mm)					MAX	MIN	Adjustment depth	Outer diameter thread	Maximum energy absorption (J)									
SM-25	24	2	66	54.5	22.5	12.5	10	M12 x 1.0	12	78	11	17	10	M6	53	12	10	
CAC4	24	2	70.5	59.5	47	37	10	M14 x 1.5	26	86	15	19	13	M8	57.5	14	12	
UCAC2	28	3	85.5	72.5	51	41	10	M20 x 1.5	70	103	19.5	24	17	M10	70.5	17	12	
MFC	36	4	114.5	96	68	58	10	M25 x 1.5	120	150	25	32	24	M16	91.5	25	20	
Symbol	SX	SY	NE	NF	NG			NH			NN	NP	NQ	NR	NT	NY	L	
Bore size (mm)					MAX	MIN	Adjustment depth	Outer diameter thread	Maximum energy absorption (J)									
Ending	37	14	56.5	50	24	14	10	M10 x 1.0	7	10	M6	50	11	8	14	244		
	42	24	61.5	54	22.5	12.5	10	M12 x 1.0	12	10	M6	54	12	11	14	268		
	48	29	74.5	66	42	32	10	M14 x 1.5	26	13	M8	66.5	16	13	19	324		
	61	40	99.5	87.5	42	32	10	M20 x 1.5	70	19	M12	88	16	20	30	452		

### Dimensions

● Position locking type (SRM3-Q)

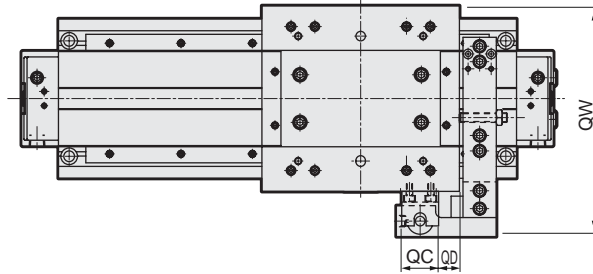

Note  
The following diagram shows the position T type switch is installed for SRM3-Q (position locking type)-25, 32, 40

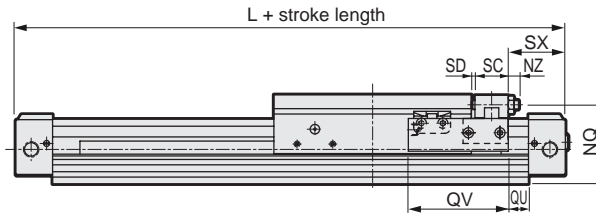
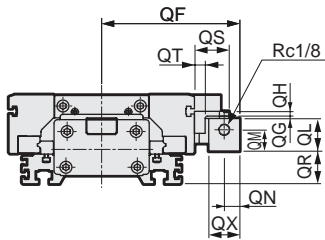
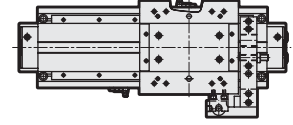

L side

R side

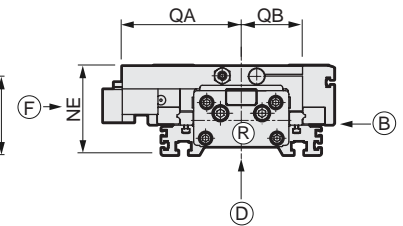

● Position locking, adjustable full-stroke and light load shock absorber (SRM3-Q-\*\*-\*\*\*-E1)



● Position locking, adjustable full-stroke and standard with shock absorber (SRM3-Q-\*\*-\*\*\*-A1)

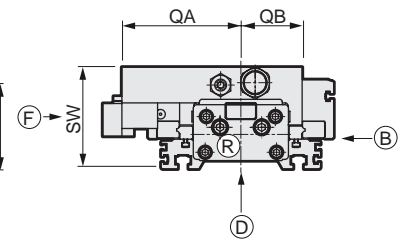
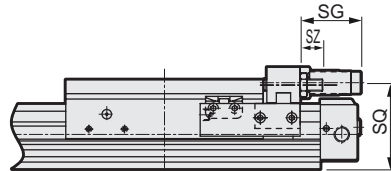
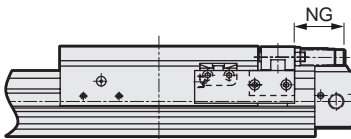

Symbol	QA	QB	QC	QD	QF	QG	QH	QL	QM	QN	QR	QS	QT	QV	QU
<b>Bore size (mm)</b>															
ø25	78	39	31	26.5	94	2	4	27.5	18	13	13	29	9	84	17
ø32	86	43	31	26.5	102	2	4	27.5	18	13	16.5	29	9	84	18
ø40	100	51.5	31	17.5	116	2	4	27.5	18	13	27.5	29	9	84	17
ø63	140	75	34	20.5	156	2	5	33	21.5	15	41	36	12	100	22
<b>Symbol</b>	<b>QX</b>	<b>QW</b>	<b>NE</b>	<b>NG</b>	<b>NQ</b>	<b>NZ</b>	<b>SC</b>	<b>SD</b>	<b>SW</b>	<b>SG</b>	<b>SQ</b>	<b>SX</b>	<b>SZ</b>	<b>L</b>	
<b>Bore size (mm)</b>															
ø25	26	150	56.5	24	50	4	24	2	66	22.5	53	37	4	244	
ø32	26	166	61.5	22.5	54	4	24	2	69.5	47	57.5	42	9	268	
ø40	26	194	74.5	42	66.5	9	28	3	85.5	51	70.5	48	19	324	
ø63	30	268	99.5	42	88	15	36	4	114.5	68	91.5	61	20	452	

SCP\*2  
CMK2  
CMA2  
SCM  
SCG  
SCA2  
SCS  
CKV2  
CA/OV2  
SSD  
CAT  
MDC2  
MVC  
SMD2  
MSD\*  
FC\*  
STK  
ULK\*  
JSK/M2  
JSG  
JSC3  
USSD  
USC  
JSB3  
LMB  
STG  
STS L  
LCS  
LCG  
LCM  
LCT  
LCY  
STR2  
UCA2  
HCM  
HCA  
SRL3  
SRG3  
SRM3  
SRT3  
MLR2  
MRG2  
SM-25  
CAC4  
UCAC2  
RCC2  
MFC  
SHC  
GLC  
Ending

Rodless type  
High precision guided rodless cylinder



### SRM3 Series selection guide

Selecting conditions are different from general cylinders. Please check if the proper product is selected according to selection guide.

#### 1 Step-1

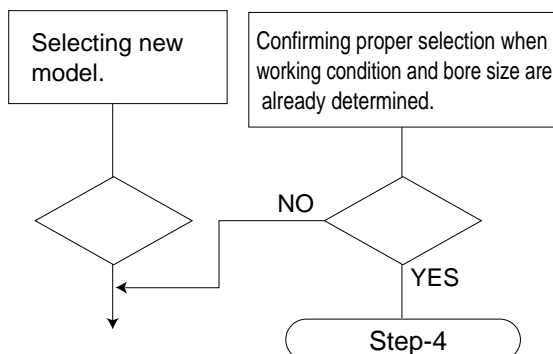

#### 2 Step-2 working conditions confirmation

1. Working pressure (P) (MPa)
2. Load weight (M) (kg)
3. Load (F<sub>L</sub>) (N)
4. Mounting direction
5. Stroke (L) (mm)
6. Moving time (t) (s)
7. Operation speed (V) (m/s)

Formula for cylinder average operation speed V.

$$V = \frac{L}{t} \times \frac{1}{1000} \text{ (m/s)}$$

(Load weight)

The value shows (load weight + jig weight)

(Mounting direction)

Operation direction horizontal, vertical-up or vertical-down

Mounting direction table upward and table downward

#### 3 Cylinder size selection of step-3 rough

● Formula of cylinder size (bore size)

$$F = \frac{\pi}{4} \times D^2 \times P \times \frac{a}{100} \text{ (N)}$$

$$\therefore D = \sqrt{\frac{4F}{\pi \cdot P \cdot a}} \text{ (mm)}$$

- D: Cylinder bore size (mm)
- P: Working pressure (MPa)
- a: Thrust efficiency (%) (refer to the fig.1.)
- F: Cylinder theoretical thrust (N)

$$D = \boxed{\varnothing}$$

Fig.1 Tendency of thrust efficiency of SRM3

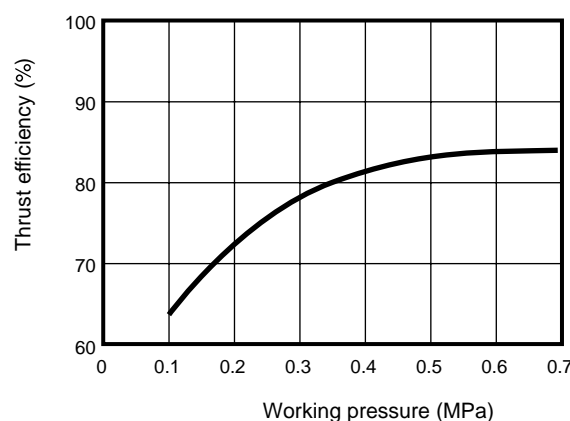

● When finding the value according to theoretical thrust value of Table 4  
 Rough required thrust  $\geq$  load x 2  
 ("x2" in "load x2" is a safety factor, when load factor is 50%)

(Example) Working pressure 0.5MPa

Load 20N

\*Necessary thrust is 20 x 2 = 40N.

$\varnothing 25$  bore is selected to meet the theoretical thrust of more than 40N at working pressure 0.5MPa according to Table 4.

$$D = \boxed{\varnothing 25}$$

(cylinder theoretical thrust)

Table 4 cylinder theoretical thrust

Unit: N

Bore size (mm)	Pressurized area (mm <sup>2</sup> )	Working pressure MPa							
		0.05	0.1	0.2	0.3	0.4	0.5	0.6	0.7
$\varnothing 25$	542	—	49	98	147	196	245	295	344
$\varnothing 32$	814	—	81	163	244	326	407	488	570
$\varnothing 40$	1266	—	127	253	380	506	633	760	886
$\varnothing 63$	3137	157	314	627	941	1255	1568	1882	2196

Note4: Values on Table 4 does not include thrust efficiency.

- SCP\*2
- CMK2
- CMA2
- SCM
- SCG
- SCA2
- SCS
- CKV2
- CA/OV2
- SSD
- CAT
- MDC2
- MVC
- SMD2
- MSD\*
- FC\*
- STK
- ULK\*
- JSK/M2
- JSG
- JSC3
- USSD
- USC
- JSB3
- LMB
- STG
- STS L
- LCS
- LCG
- LCM
- LCT
- LCY
- STR2
- UCA2
- HCM
- HCA
- SRL3
- SRG3
- SRM3**
- SRT3
- MRL2
- MRG2
- SM-25
- CAC4
- UCAC2
- RCC2
- MFC
- SHC
- GLC

Ending

Rodless type  
High precision guided rodless cylinder

### 4 Step-4 Calculation of load (W), each moment value

● Calculate static load (W), moment (M1, M2, M3) according to load installation condition onto cylinder.

$$W = W \text{ (N)}$$

$$M1 = F1 \times l1 \text{ (N} \cdot \text{m)}$$

$$M2 = F2 \times l2 \text{ (N} \cdot \text{m)}$$

$$M3 = F3 \times l3 \text{ (N} \cdot \text{m)}$$

Substitute the loads applied on Fig.2 to the values F1, F2, F3.

Fig.2 Formula of each moment

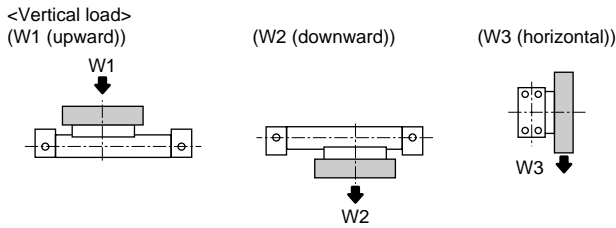

<Bending moment >  $M1 = F1 \times l1$

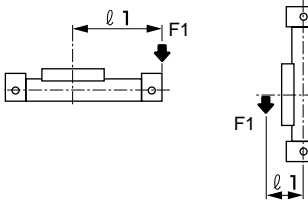

<Radial moment >  $M2 = F2 \times l2$

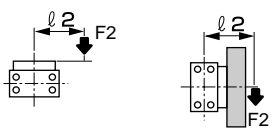

<Twist moment >  $M3 = F3 \times l3$

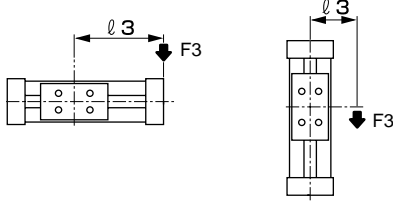

(example)

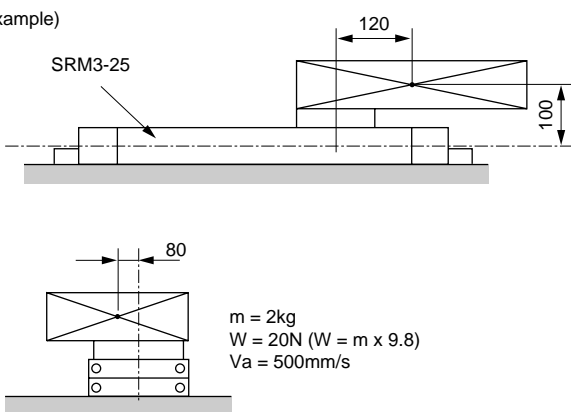

Working pressure  $P = 0.5\text{MPa}$

$$M1 = 20 \times 0.12 = 2.4\text{N} \cdot \text{m}$$

$$M2 = 20 \times 0.08 = 1.6\text{N} \cdot \text{m}$$

$$M3 = 0$$

$W = 20\text{N}$	$M1 = 2.4\text{N} \cdot \text{m}$	$M2 = 1.6\text{N} \cdot \text{m}$	$M3 = 0$
------------------	-----------------------------------	-----------------------------------	----------

### 5 Step-5 Composite value confirmation of load and moment

Table 5 Max. allowable of load and moment

Descriptions	Vertical load W1max : N	Vertical load W2max : N	Vertical load W3max : N
Bore size (mm)			
ø25	100	80	100
ø32	240	190	240
ø40	400	320	400
ø63	1300	1000	1300

Descriptions	Bending moment M1max : N · m	Radial moment M2max : N · m	Twisting moment M3max : N · m
Bore size (mm)			
ø25	16	18	16
ø32	25	28	25
ø40	50	60	50
ø63	200	260	200

Table 5 indicates the max. allowable value. The allowable value varies as Fig.3 to Fig.8 depends on working speed conditions.

(The bottom left side of the characteristics curve on Fig.3 to Fig.8 can be used)

Fig.3 W1, W2, W3 allowable load of SRM3-25, 32

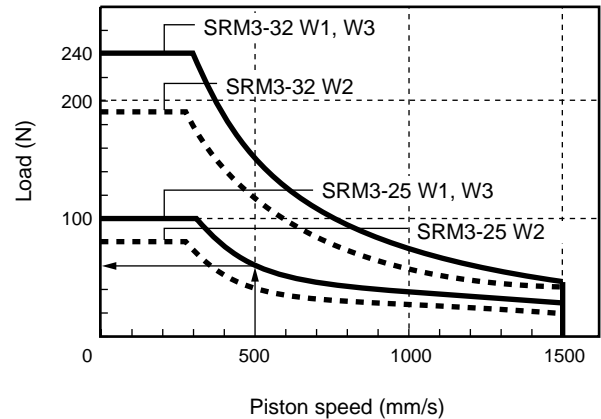

Fig4. W1, W2, W3 allowable load of SRM3-40, 63

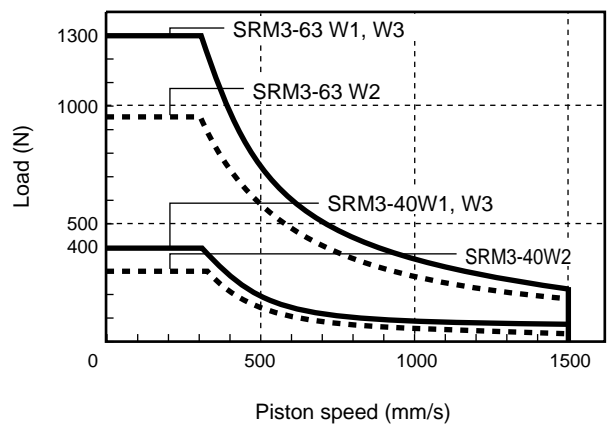

Fig. 5 M1, M3 allowable moment of SRM3-25, 32

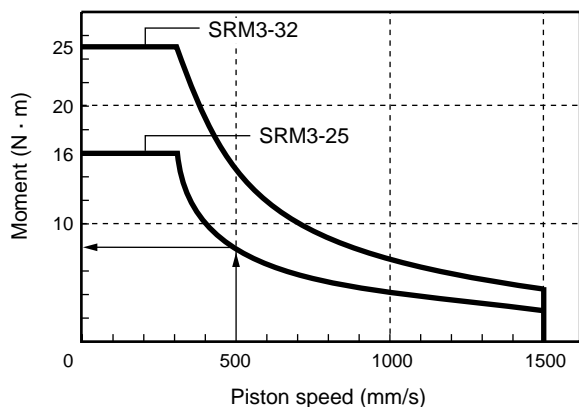

Fig. 6 M1, M3 allowable moment of SRM3-40, 63

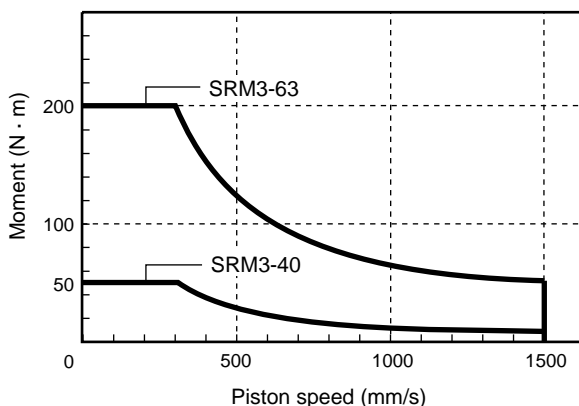

Fig. 7 M2 allowable moment of SRM3-25, 32

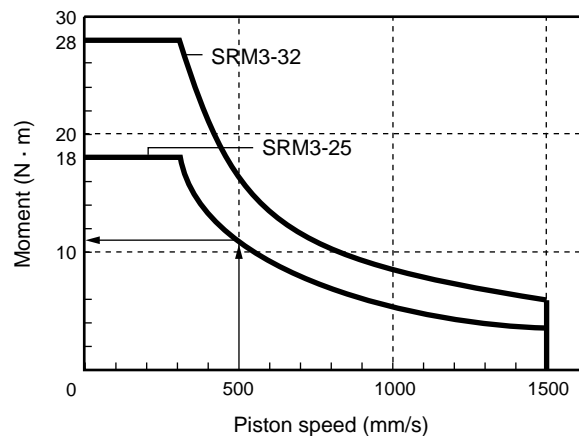
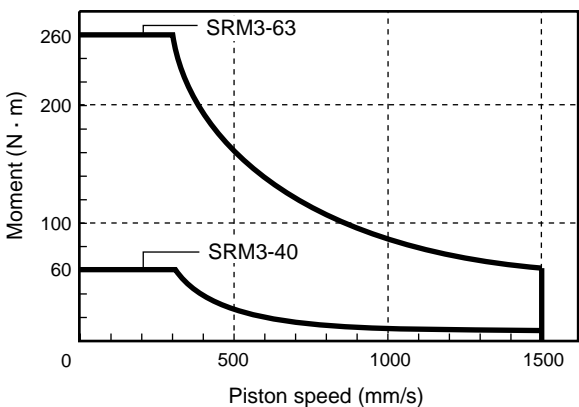

Fig. 8 M2 allowable moment of SRM3-40, 63



● Divide each load by allowable values from Fig.3 and 8 to find load and moment ratio, then confirm that the total is 1.0 or less.

Formula

$$\frac{W}{W_{max'}} + \frac{M1}{M1_{max'}} + \frac{M2}{M2_{max'}} + \frac{M3}{M3_{max'}} \leq 1.0$$

$W_{max'}$ ,  $M1_{max'}$ ,  $M2_{max'}$ ,  $M3_{max'}$  are the values from Fig. 3 and 8. Read value

- When the total is larger than 1.0
  1. Reexamine load
  2. Select a larger cylinder bore size

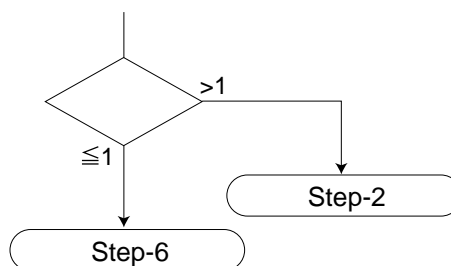

<Example>

Operation speed 500mm/s  
 $W=20N$ ,  $M1=2.4N \cdot m$ ,  $M2=1.6N \cdot m$ ,  $M3=0N \cdot m$   
 Cylinder size used. : Equivalent to  $\phi 25$ .

From Fig. 3  $W_{max'} = 60N$   
 From Fig. 5  $M1_{max'} = 8N \cdot m$   
 $M3_{max'} = 8N \cdot m$   
 From Fig. 7  $M2_{max'} = 11N \cdot m$

$$\frac{20}{60} + \frac{2.4}{8} + \frac{1.6}{11} + \frac{0}{8} = 0.78 \leq 1.0$$

Since the total of load, moment ration is 1.0 or less, this is OK.

SCP*2
CMK2
CMA2
SCM
SCG
SCA2
SCS
CKV2
CA/OV2
SSD
CAT
MDC2
MVC
SMD2
MSD*
FC*
STK
ULK*
JSK/M2
JSG
JSC3
USSD
USC
JSB3
LMB
STG
STSL
LCS
LCG
LCM
LCT
LCY
STR2
UCA2
HCM
HCA
SRL3
SRG3
<b>SRM3</b>
SRT3
MRL2
MRG2
SM-25
CAC4
UCAC2
RCC2
MFC
SHC
GLC
Ending

Rodless type  
High precision guided rodless cylinder



## Selection guide

SCP*2
CMK2
CMA2
SCM
SCG
SCA2
SCS
CKV2
CA/OV2
SSD
CAT
MDC2
MVC
SMD2
MSD*
FC*
STK
ULK*
JSK/M2
JSG
JSC3
USSD
USC
JSB3
LMB
STG
STS L
LCS
LCG
LCM
LCT
LCY
STR2
UCA2
HCM
HCA
SRL3
SRG3
<b>SRM3</b>
SRT3
MRL2
MRG2
SM-25
CAC4
UCAC2
RCC2
MFC
SHC
GLC
Ending

### 6 Step-6 Calculation of necessary thrust

Calculate required cylinder thrust (FN)

1. During horizontal operation

$$F_N = W \times 0.2 \text{ (N)}$$

2. During vertical operation

$$F_N = W \text{ (N)}$$

<Example>

$$W = 20\text{N}$$

Used cylinder size.:  $\varnothing 25$ , horizontal operation.

$$F_N = 20 \times 0.2 = 4 \text{ (N)}$$

### 7 Step-7 Load factor confirmation

● Load factor is determined according to stability of cylinder operation speed, safety factor and service life, etc.

● Formula of load factor ( $\alpha$ )

$$\alpha = \frac{\text{Necessary thrust (FN)}}{\text{Cylinder thrust (F)}} \times 100 \%$$

$$F = \frac{\pi}{4} \times D^2 \times P \times \frac{\mu}{100} \text{ (N)}$$

D: Cylinder bore size (mm)

$$\frac{\pi}{4} \times D^2 = \text{pressurized area (mm}^2\text{)}$$

● Cylinder theoretical thrust value on Table 4 may be used as

a value of  $\frac{\pi}{4} \times D^2 \times P$ .

P : Working pressure MPa

The  $\mu$  : thrust coefficient Fig.1 value is used.

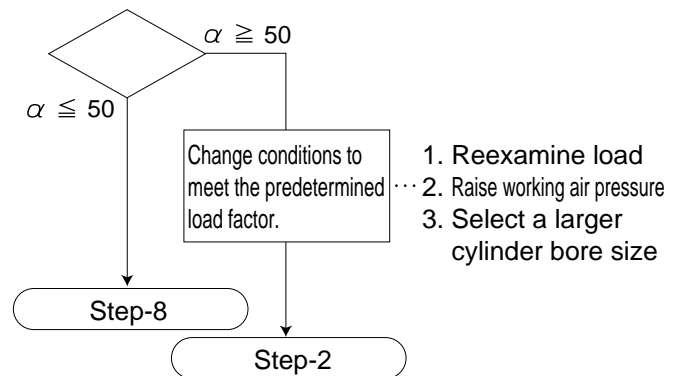

<Adequate range of load factor>

● Speed of piston varies depending on load factor but use within the range shown on Table 6 is recommended for general use.

Table 6 (Adequate range of load factor - reference value)

Working pressure MPa	Load factor
0.2 to 0.3	$\alpha \leq 40$
0.3 to 0.6	$\alpha \leq 50$
0.6 to 0.7	$\alpha \leq 60$

(Example) Used cylinder size. : Equivalent to  $\varnothing 25$ .

Necessary thrust 4N

Working pressure : 0.5MPa

$$\alpha = \frac{4}{542 \times 0.5 \times \frac{83}{100}} \times 100$$

$$= 2\%$$

$$\alpha \leq 50\%, \text{ so it is OK.}$$

### 8 Step-8 Cushion performance confirmation

Check if the kinetic energy of actual load can be absorbed according to cushion faculty of cylinder.

● The allowable energy absorption of cylinder ( $E_1$ ) is the characteristic value of cylinder. For SRM, use the values on Table 7.

● Formula of piston kinetic energy ( $E_2$ )

$$E_2 = \frac{1}{2} \times M \times V^2 \quad (\text{J})$$

M: Weight of load (kg)

V: Entry speed into the cushion (m/s)

$$V = \frac{L}{t} \times \left(1 + 1.5 \times \frac{\alpha}{100}\right)$$

L: Stroke (m)

t: Operation time (S)

$\alpha$ : Load factor (%)

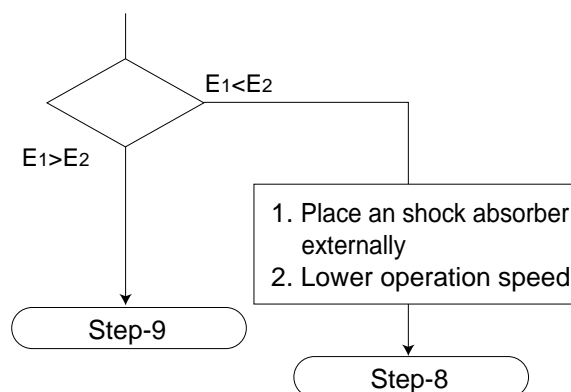

<Cylinder allowable energy absorption>

● The amount of kinetic energy absorbable by the cushion mechanism depends on the cylinder bore size.

SRM3 is compared using values on table 7.

Table 7 Allowable energy absorption of SRM3 ( $E_1$ )

Bore size (mm)	Allowable absorbing energy (J)
ø25	1.40
ø32	2.57
ø40	4.27
ø63	17.4

### 9 Step-9 Inertia load confirmation

● Check if the kinetic energy of actual load can be absorbed according to cushion faculty of cylinder.

(1) Calculate inertia force ( $F_1$ ) from entry speed into the cushion ( $V$ ) and inertia force coefficient of SRM on Fig 9.

$$F_1 = 10 \times M \times G \quad (\text{N})$$

m: Load weight (kg)

G: Inertia force coefficient

(2) Find bending moment ( $M_{3i}$ ) according to inertia force ( $F_1$ )

$$M_{1i} = F_1 \times \ell_1$$

$$M_{3i} = F_1 \times \ell_3$$

(3) Add static load moment ( $M_1$  and  $M_3$ ) to inertia load moment ( $M_{1i}$  and  $M_{3i}$ ). Confirm if the composite value is less than maximum allowable value on Table 5.

$$M_1 + M_{1i} \leq M_{1\text{max.}}$$

$$M_3 + M_{3i} \leq M_{3\text{max.}}$$

Refer to table 5 for the value of  $M_{1\text{max.}}$  and  $M_{3\text{max.}}$

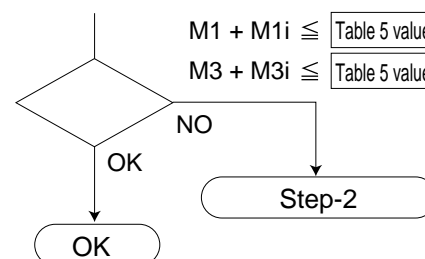

( $M_1$  and  $M_3$  occurs simultaneously)

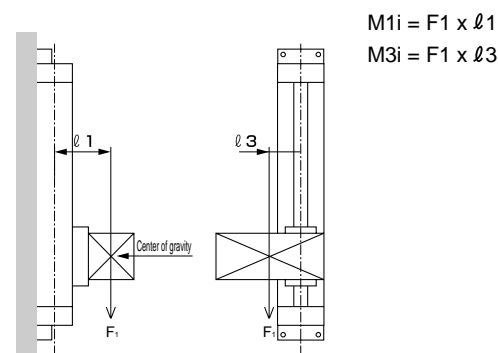
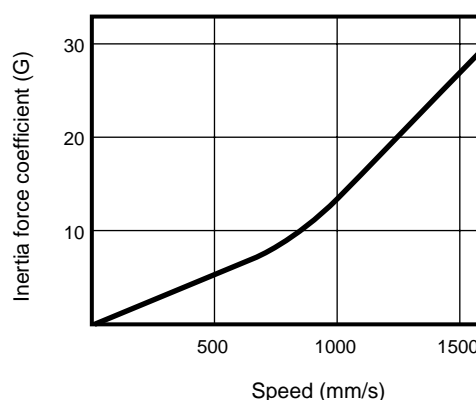

Fig 9. Tendency of inertia force coefficient of SRM3



SCP\*2  
CMK2  
CMA2  
SCM  
SCG  
SCA2  
SCS  
CKV2  
CA/OV2  
SSD  
CAT  
MDC2  
MVC  
SMD2  
MSD\*  
FC\*  
STK  
ULK\*  
JSK/M2  
JSG  
JSC3  
USSD  
USC  
JSB3  
LMB  
STG  
STS L  
LCS  
LCG  
LCM  
LCT  
LCY  
STR2  
UCA2  
HCM  
HCA  
SRL3  
SRG3  
SRM3  
SRT3  
MRL2  
MRG2  
SM-25  
CAC4  
UCAC2  
RCC2  
MFC  
SHC  
GLC

Ending

Rodless type  
High precision guided rodless cylinder

## Technical data

### 1 Cushioning characteristics and kinetic energy

#### (1) cushion

##### ● Cushion

Cushion is a function to prevent piston and cover from colliding with large impact at stroke limit using air compressibility to absorb the piston's kinetic energy, but not decelerate the piston speed at the point close to the stroke limit.

Table 8 shows the kinetic energy absorbed by cushion. When a kinetic energy exceeds this value, or bounce by air compressibility should be avoided, select a type with shock absorber or install an external shock absorber.

(Refer to Step 8 on previous section )

##### ● SRM3 cushioning characteristics

#### Table 8 cushion allowable energy absorption (E<sub>1</sub>)

Bore size (mm)	Valid cushion Length (mm)	Allowable energy absorption J	
		Cushioned	No cushion
ø25	20.9	1.40	0.015
ø32	23.5	2.57	0.030
ø40	23.9	4.27	0.050
ø63	29.6	17.4	0.138

##### ● Formula of kinetic energy (E<sub>2</sub>)

$$E_2 = \frac{1}{2} \times M \times v^2 \quad (\text{J})$$

$J$  : Cylinder stroke (m)  
 $t$  : Operation time of piston (s)  
 $m$ : Load weight (kg)  
 $\alpha$  : Cylinder load factor (%)  
 Cushion of V: piston  
 Entry speed (m/s)

$$\alpha = \frac{\text{Load}}{\text{Cylinder thrust}} \times 100$$

$$V = \frac{L}{t} \times \left(1 + 1.5 \times \frac{\alpha}{100}\right)$$

#### (2) shock absorber

Table 10 shows shock absorbers used for SRM with shock absorber. Please use this within specifications range of shock absorber on Table 9.

#### Table 9 specifications

Shock absorber model no.	NCK-00-0.7-C	NCK-00-1.2	NCK-00-2.6	NCK-00-7	NCK-00-12
<b>Descriptions</b>	Without adjuster spring return type				
Type/category					
Maximum energy absorption J	7	12	26	70	120
Stroke length mm	8	10	15	20	25
Maximum energy absorption per hour KJ/	12,600	21,600	39,000	84,000	86,400
Max. colliding speed m/s	1.5	2.0	2.5	3.0	
Max. repeating cycle Time/min.	30		25	20	12
Ambient temperature °C	-10 to 80				
Required strength of mounting bracket N	6150	8400	12100	24400	33500
Return time S	0.3 or less			0.4 or less	
Product weight kg	0.02	0.04	0.07	0.2	0.3
Return Extended N	2.0	2.9	5.9	9.8	16.3
Spring force Compressed N	4.3	5.9	11.8	21.6	33.3

● Allowable energy absorption differs depending on the colliding speed at SRM3. When colliding speed is 1000mm/s to 1500mm/s, the value should not be larger than half of maximum energy absorption on Table 9.

#### Table 10 shock absorber model

Model	Shock absorber model	
	Standard type (-A)	Light load type (-E)
SRM3-25	NCK-00-1.2	NCK-00-0.7-C
SRM3-32	NCK-00-2.6	NCK-00-1.2
SRM3-40	NCK-00-7	NCK-00-2.6
SRM3-63	NCK-00-12	NCK-00-7

##### ● Confirming allowable colliding energy of shock absorber

Calculate colliding energy E and colliding object equivalent weight Me according to the formula on the table below, and confirm if Me should not be greater than the allowable values of Fig. 10.

Allowable value of colliding object equivalent weight Me and colliding energy E may vary depending on colliding speed.

##### ● Symbol

- E : Colliding energy (J)
- Me : Colliding weight or equivalent (kg)
- m : Weight of workpiece (kg)
- F : Cylinder thrust (N)
- V : Colliding speed (m/s)
- St : mm stroke of shock absorber (m)
- g : Gravity acceleration 9.8 (m/s<sup>2</sup>)

	Horizontal movement	Moving downward	Moving upward
Applications			
Colliding or equivalent weight Me (kg)	$Me = m + \frac{2F/St}{V^2}$	$Me = m + \frac{2/St(F+mg)}{V^2}$	$Me = m + \frac{2/St(F-mg)}{V^2}$
Energy E (J)	$E = \frac{mV^2}{2} + F/St$	$E = \frac{mV^2}{2} + (F+mg)/St$	$E = \frac{mV^2}{2} + (F-mg)/St$

Fig.10 Allowable value of weight equivalent to colliding object

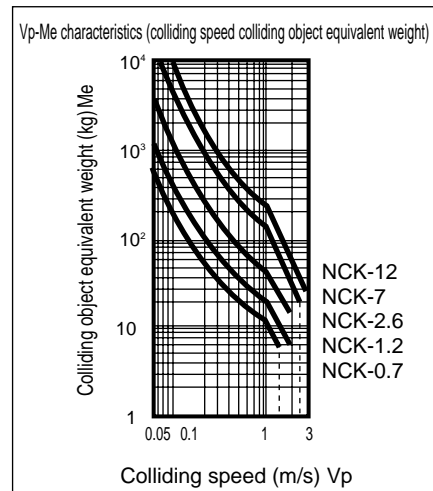

●With cushion/shock absorber Transfer weight - speed characteristics

The following diagram shows transfer weight - speed characteristics. Since the value may vary according to working conditions, please check if the values are less than the allowable values on Table 9.

### SRM3 cushion/with shock absorber Transfer weight-speed characteristics

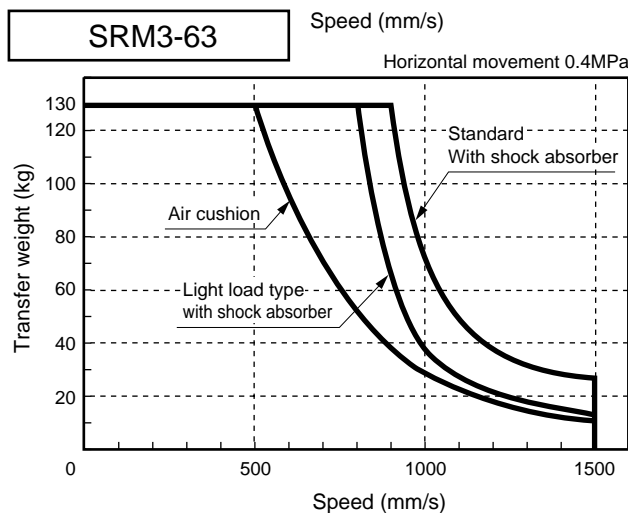
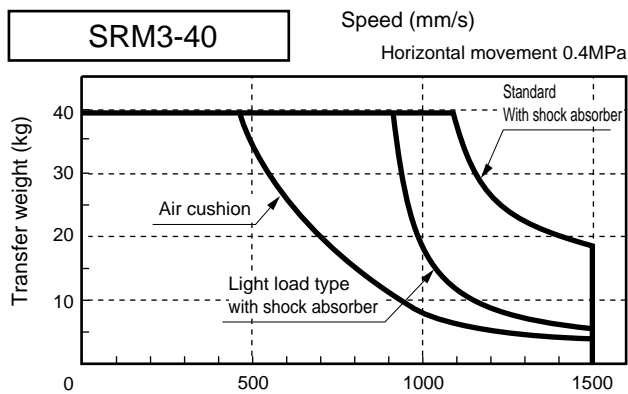
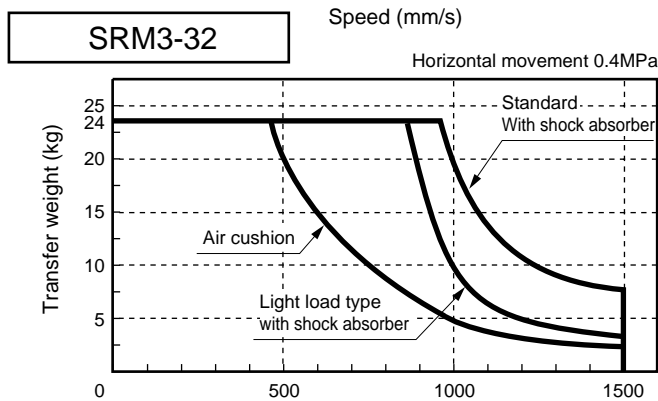
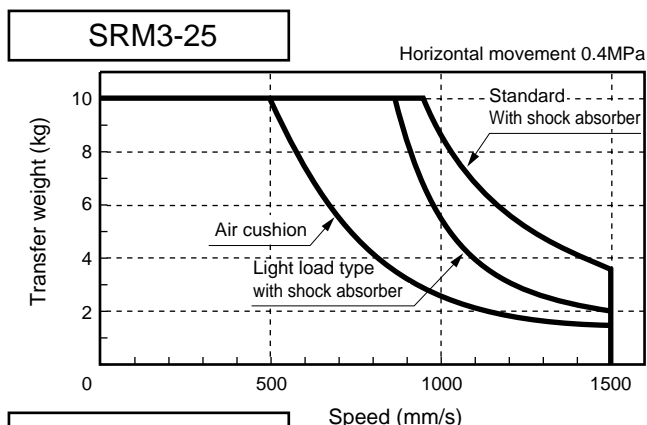

### Cautions on use

The rated stroke length of shock absorber absorbs the rated energy. A shock absorber is installed at the position where the shock absorber has some safety margin to its stroke limit when the cylinder reached the stroke limit.

Therefore, absorbed energy is smaller than allowable energy absorption of discrete shock absorber (refer to Table 11). When the rated absorbed energy is necessary, adjust the shock absorber so as its stroke reaches the stroke limit.

Table 11 Default specifications with shock absorber

Model	Standard type (-A)		Light load type (-E)	
	Absorbed energy (J)	Valid mm stroke (mm)	Absorbed energy (J)	Valid mm stroke (mm)
SRM3-25	10	9	5.7	7
SRM3-32	18	13	10	9
SRM3-40	50	16.5	18	13
SRM3-63	86	21	50	16.5

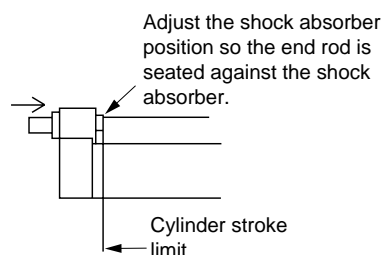
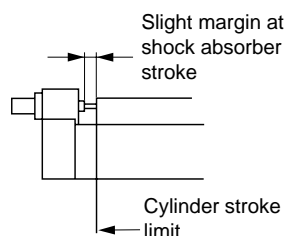

(note) This is the explanation of shock absorber included in full stroke adjustment types.

### Adjustment of shock absorber

Absorbed energy of shock absorber can be adjusted by changing operation stroke length of shock absorber

- SCP\*2
- CMK2
- CMA2
- SCM
- SCG
- SCA2
- SCS
- CKV2
- CA/OV2
- SSD
- CAT
- MDC2
- MVC
- SMD2
- MSD\*
- FC\*
- STK
- ULK\*
- JSK/M2
- JSG
- JSC3
- USSD
- USC
- JSB3
- LMB
- STG
- STS L
- LCS
- LCG
- LCM
- LCT
- LCY
- STR2
- UCA2
- HCM
- HCA
- SRL3
- SRG3
- SRM3**
- SRT3
- MRL2
- MRG2
- SM-25
- CAC4
- UCAC2
- RCC2
- MFC
- SHC
- GLC
- Ending

Rodless type  
High precision guided rodless cylinder

## Technical data

### ● Example of calculation (for SRM3-25-A)

Applicable shock absorber NCK-00-1.2

- Example of calculation (1) when lifting up, when lifting down

Working conditions

- Load weight m 3kg
- Colliding speed  
0.5 m/s when lifting up  
1.0m/s when lifting down
- Working pressure 0.5MPa  
(245N)

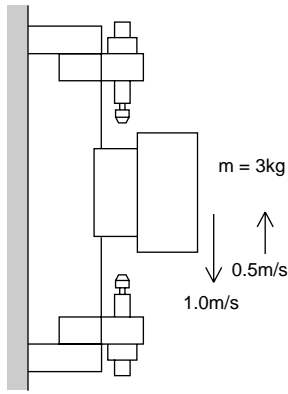

#### (1) Kinetic energy of when lifting up (E1)

$$E_1 = \frac{3 \times 0.5^2}{2} + (245 - 3 \times 9.8) \times 0.01$$

$$= 2.5 \text{ (J)}$$

Since the value is less than energy absorption on Table 9, kinetic energy (E1) can be absorbed.

$$Me = 3 + \frac{2 \times 0.01 \times (245 - 3 \times 9.8)}{0.5^2}$$

$$= 20 \text{ (kg)}$$

The Me of the shock absorber used for SRM3-25-A is fig.10.

Selected can be absorbed by V = 0.5m/s time 32kg

#### (2) Kinetic energy when lifting down (E1)

$$E_1 = \frac{3 \times 1.0^2}{2} + (245 + 3 \times 9.8) \times 0.01$$

$$= 4.2 \text{ (J)}$$

Since the value is less than half of maximum energy absorption on Table 9, kinetic energy (E1) can be absorbed.

$$Me = 3 + \frac{2 \times 0.01 \times (245 + 3 \times 9.8)}{1.0^2}$$

$$= 8.5 \text{ (kg)}$$

Me of shock absorber used for SRM3-25-A, as Fig. 10 shows, is 24kg when V=1.0m/s. This value can be absorbed.

### ● Example of calculation (2) horizontal

Working conditions

- Load weight M 2kg
- Colliding speed  
Horizontal 1.5m/s
- Working pressure 0.3MPa  
(147N)

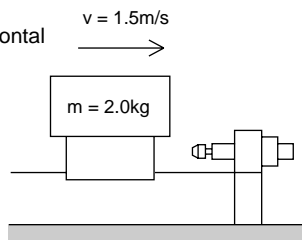

Kinetic energy of horizontal (E1)

$$E_1 = \frac{2 \times 1.5^2}{2} + 147 \times 0.01$$

$$= 3.7 \text{ (J)}$$

The value is less than half of max. energy absorption on Table 10. Kinetic energy (E1) can be absorbed.

$$Me = 2 + \frac{2 \times 147 \times 0.01}{1.5^2}$$

$$= 3.3 \text{ (kg)}$$

Fig. 10 shows Me value of shock absorber for SRM-25-A as 10kg when V=1.5m/s. Since 3.4<10, this can be absorbed

(note) Refer to selection guide 9 Step-9 "confirming inertia load" about inertia load. The allowable value should not be exceeded.

### 2 Deflection of table (displacement at table end)

The table below shows the displacement at the table end when moment is applied.

The right table shows the position of table end.

Model	a	b	c
SRM3-25	50	50	50
SRM3-32	55	55	55
SRM3-40	70	70	70
SRM3-63	100	100	100

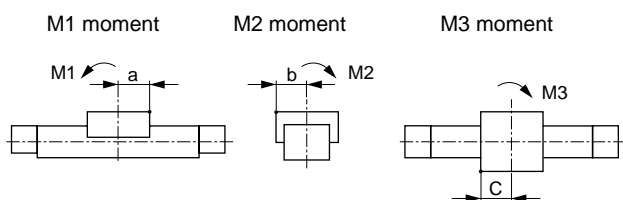

#### ● SRM3-25

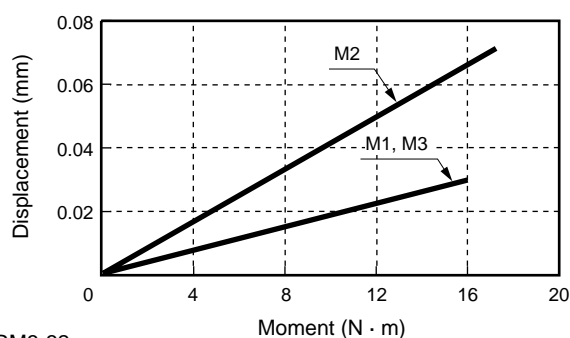

#### ● SRM3-32

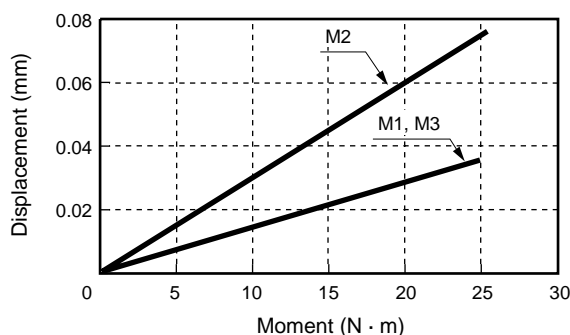

#### ● SRM3-40

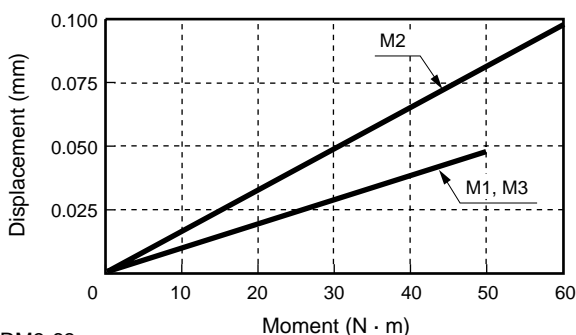

#### ● SRM3-63

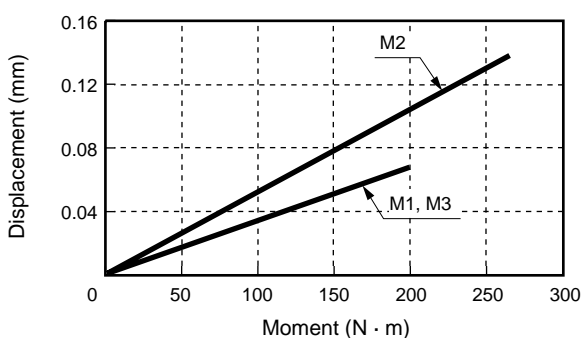

### 3 Support interval

Too much stroke, load or bending moment may increase deflection of tube. Please fix the tube according to the intervals on the table shown below.

Model	Recommended support interval ( $l$ ) mm
SRM3-25	400
SRM3-32	400
SRM3-40	500
SRM3-63	600

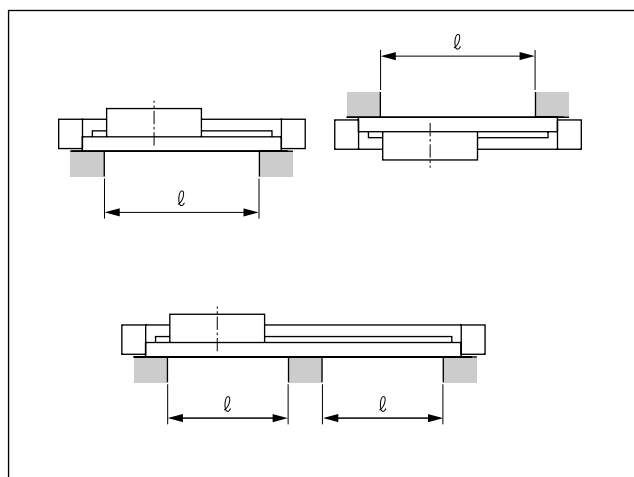

SCP*2
CMK2
CMA2
SCM
SCG
SCA2
SCS
CKV2
CA/OV2
SSD
CAT
MDC2
MVC
SMD2
MSD*
FC*
STK
ULK*
JSK/M2
JSG
JSC3
USSD
USC
JSB3
LMB
STG
STS L
LCS
LCG
LCM
LCT
LCY
STR2
UCA2
HCM
HCA
SRL3
SRG3
<b>SRM3</b>
SRT3
MRL2
MRG2
SM-25
CAC4
UCAC2
RCC2
MFC
SHC
GLC
Ending

Rodless type  
High precision guided rodless cylinder